



PortableGrand DGX-670
Owner's Manual

Thank you for purchasing this Yamaha Digital Piano!

This instrument provides a comprehensive array of authentic voices and a superb grand piano touch with versatile functions.

We recommend that you read this manual carefully so that you can fully take advantage of the advanced and convenient functions of the instrument. We also recommend that you keep this manual in a safe and handy place for future reference.

Before using the instrument, be sure to read "PRECAUTIONS" on pages 4-5.



Information for users on collection and disposal of old equipment:

This symbol on the products, packaging, and/or accompanying documents means that used electrical and electronic products should not be mixed with general household waste.

For proper treatment, recovery and recycling of old products, please take them to applicable collection points, in accordance with your national legislation.

By disposing of these products correctly, you will help to save valuable resources and prevent any potential negative effects on human health and the environment which could otherwise arise from inappropriate waste handling.

For more information about collection and recycling of old products, please contact your local municipality, your waste disposal service or the point of sale where you purchased the items.

For business users in the European Union:

If you wish to discard electrical and electronic equipment, please contact your dealer or supplier for further information.

Information on Disposal in other Countries outside the European Union:

This symbol is only valid in the European Union. If you wish to discard these items, please contact your local authorities or dealer and ask for the correct method of disposal.

(weee_en_en_02)

FCC INFORMATION (U.S.A.)

1. IMPORTANT NOTICE: DO NOT MODIFY THIS UNIT!

This product, when installed as indicated in the instructions contained in this manual, meets FCC requirements. Modifications not expressly approved by Yamaha may void your authority, granted by the FCC, to use the product.

2. IMPORTANT:

When connecting this product to accessories and/or another product use only high quality shielded cables. Cable/s supplied with this product MUST be used. Follow all installation instructions. Failure to follow instructions could void your FCC authorization to use this product in the USA.

3. NOTE:

This product has been tested and found to comply with the requirements listed in FCC Regulations, Part 15 for Class "B" digital devices. Compliance with these requirements provides a reasonable level of assurance that your use of this product in a residential environment will not result in harmful interference with other electronic devices. This equipment generates/uses radio frequencies and, if not installed and used according to the instructions found in the users manual, may cause interference harmful to the operation of other electronic

devices. Compliance with FCC regulations does not guarantee that interference will not occur in all installations. If this product is found to be the source of interference, which can be determined by turning the unit "OFF" and "ON", please try to eliminate the problem by using one of the following measures:

Relocate either this product or the device that is being affected by the interference.

Utilize power outlets that are on different branch (circuit breaker or fuse) circuits or install AC line filter/s.

In the case of radio or TV interference, relocate/reorient the antenna. If the antenna lead-in is 300 ohm ribbon lead, change the lead-in to co-axial type cable.

If these corrective measures do not produce satisfactory results, please contact the local retailer authorized to distribute this type of product. If you can not locate the appropriate retailer, please contact Yamaha Corporation of America, Electronic Service Division, 6600 Orangethorpe Ave, Buena Park, CA90620

The above statements apply ONLY to those products distributed by Yamaha Corporation of America or its subsidiaries.

* This applies only to products distributed by Yamaha Corporation of America.

(class B)

COMPLIANCE INFORMATION STATEMENT (Supplier's declaration of conformity procedure)

Responsible Party : Yamaha Corporation of America
Address : 6600 Orangethorpe Ave., Buena Park, Calif. 90620
Telephone : 714-522-9011
Type of Equipment : Digital Piano
Model Name : DGX-670

This device complies with Part 15 of the FCC Rules.

Operation is subject to the following two conditions:

- 1) this device may not cause harmful interference, and
- 2) this device must accept any interference received including interference that may cause undesired operation.

* This applies only to products distributed by Yamaha Corporation of America.

(FCC SDoC)

The model number, serial number, power requirements, etc., may be found on or near the name plate, which is at the bottom of the unit. You should note this serial number in the space provided below and retain this manual as a permanent record of your purchase to aid identification in the event of theft.



The name plate is located on the bottom of the unit.

Model No.

Serial No.

(bottom_en_01)

For the AC adaptor

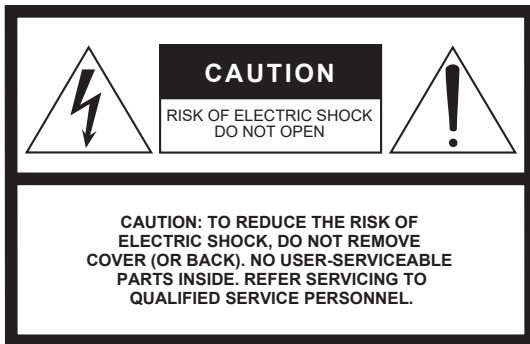

Explanation of Graphical Symbols

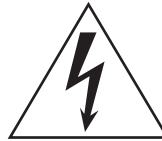

The lightning flash with arrowhead symbol within an equilateral triangle is intended to alert the user to the presence of uninsulated “dangerous voltage” within the product’s enclosure that may be of sufficient magnitude to constitute a risk of electric shock to persons.



The exclamation point within an equilateral triangle is intended to alert the user to the presence of important operating and maintenance (servicing) instructions in the literature accompanying the product.

IMPORTANT SAFETY INSTRUCTIONS

- 1 Read these instructions.
- 2 Keep these instructions.
- 3 Heed all warnings.
- 4 Follow all instructions.
- 5 Do not use this apparatus near water.
- 6 Clean only with dry cloth.
- 7 Do not block any ventilation openings. Install in accordance with the manufacturer’s instructions.
- 8 Do not install near any heat sources such as radiators, heat registers, stoves, or other apparatus (including amplifiers) that produce heat.
- 9 Do not defeat the safety purpose of the polarized or grounding-type plug. A polarized plug has two blades with one wider than the other. A grounding type plug has two blades and a third grounding prong. The wide blade or the third prong are provided for your safety. If the provided plug does not fit into your outlet, consult an electrician for replacement of the obsolete outlet.
- 10 Protect the power cord from being walked on or pinched particularly at plugs, convenience receptacles, and the point where they exit from the apparatus.
- 11 Only use attachments/accessories specified by the manufacturer.
- 12 Use only with the cart, stand, tripod, bracket, or table specified by the manufacturer, or sold with the apparatus. When a cart is used, use caution when moving the cart/apparatus combination to avoid injury from tip-over.
- 13 Unplug this apparatus during lightning storms or when unused for long periods of time.
- 14 Refer all servicing to qualified service personnel. Servicing is required when the apparatus has been damaged in any way, such as power-supply cord or plug is damaged, liquid has been spilled or objects have fallen into the apparatus, the apparatus has been exposed to rain or moisture, does not operate normally, or has been dropped.



WARNING

TO REDUCE THE RISK OF FIRE OR ELECTRIC SHOCK, DO NOT EXPOSE THIS APPARATUS TO RAIN OR MOISTURE.

(UL60065_03)

PRECAUTIONS

PLEASE READ CAREFULLY BEFORE PROCEEDING

Please keep this manual in a safe and handy place for future reference.

For the AC adaptor



WARNING

- This AC adaptor is designed for use with only Yamaha electronic instruments. Do not use for any other purpose.
- Indoor use only. Do not use in any wet environments.



CAUTION

- When setting up, make sure that the AC outlet is easily accessible. If some trouble or malfunction occurs, immediately turn off the power switch of the instrument and disconnect the AC adaptor from the outlet. When the AC adaptor is connected to the AC outlet, keep in mind that electricity is flowing at the minimum level, even if the power switch is turned off. When you are not using the instrument for a long time, make sure to unplug the power cord from the wall AC outlet.

For the instrument



WARNING

Always follow the basic precautions listed below to avoid the possibility of serious injury or even death from electrical shock, short-circuiting, damages, fire or other hazards. These precautions include, but are not limited to, the following:

Power supply/AC adaptor

- Do not place the power cord near heat sources such as heaters or radiators. Also, do not excessively bend or otherwise damage the cord, or place heavy objects on it.
- Only use the voltage specified as correct for the instrument. The required voltage is printed on the name plate of the instrument.
- Use the specified adaptor (page 107) only. Using the wrong adaptor can result in damage to the instrument or overheating.
- Use only the supplied power cord/plug.
- Check the electric plug periodically and remove any dirt or dust which may have accumulated on it.

Do not open

- This instrument contains no user-serviceable parts. Do not open the instrument or attempt to disassemble or modify the internal components in any way. If it should appear to be malfunctioning, discontinue use immediately and have it inspected by qualified Yamaha service personnel.

Water warning

- Do not expose the instrument to rain, use it near water or in damp or wet conditions, or place on it any containers (such as vases, bottles or glasses) containing liquids which might spill into any openings. If any liquid such as water seeps into the instrument, turn off the power immediately and unplug the power cord from the AC outlet. Then have the instrument inspected by qualified Yamaha service personnel.
- Never insert or remove an electric plug with wet hands.

Fire warning

- Do not put burning items, such as candles, on the unit. A burning item may fall over and cause a fire.

Influences on electro-medical devices

- Radio waves may affect electro-medical devices.
 - Do not use this product near medical devices or inside areas in which the use of radio waves is restricted.
 - Do not use this product within 15cm (6 in.) of persons with a heart pacemaker or defibrillator implant.

If you notice any abnormality

- When one of the following problems occur, immediately turn off the power switch and disconnect the electric plug from the outlet. Then have the device inspected by Yamaha service personnel.
 - The power cord or plug becomes frayed or damaged.
 - It emits unusual smells or smoke.
 - Some object has been dropped into the instrument.
 - There is a sudden loss of sound during use of the instrument.
 - If any cracks or breakages exist on the instrument.



CAUTION

Always follow the basic precautions listed below to avoid the possibility of physical injury to you or others, or damage to the instrument or other property. These precautions include, but are not limited to, the following:

Power supply/AC adaptor

- Do not connect the instrument to an electrical outlet using a multiple-connector. Doing so can result in lower sound quality, or possibly cause overheating in the outlet.
- When removing the electric plug from the instrument or an outlet, always hold the plug itself and not the cord. Pulling by the cord can damage it.
- Remove the electric plug from the outlet when the instrument is not to be used for extended periods of time, or during electrical storms.

Location

- Do not place the instrument in an unstable position where it might accidentally fall over.
- Do not go near the instrument during an earthquake. Strong shaking during an earthquake could cause the instrument to move or tip over, resulting in damage to the instrument or its parts, and possibly causing injury.
- When transporting or moving the instrument, always use two or more people. Attempting to lift the instrument by yourself may damage your back, result in other injury, or cause damage to the instrument itself.
- Before moving the instrument, remove all connected cables, to prevent damage to the cables or injury to anyone who might trip over them.
- When setting up the product, make sure that the AC outlet you are using is easily accessible. If some trouble or malfunction occurs, immediately turn off the power switch and disconnect the plug from the outlet. Even when the power switch is turned off, electricity is still flowing to the product at the minimum level. When you are not using the product for a long time, make sure to unplug the power cord from the wall AC outlet.
- Use only the stand specified for the instrument (page 15). When attaching it, use the provided screws only. Failure to do so could cause damage to the internal components or result in the instrument falling over.

Connections

- Before connecting the instrument to other electronic components, turn off the power for all components. Before turning the power on or off for all components, set all volume levels to minimum.
- Be sure to set the volumes of all components at their minimum levels and gradually raise the volume controls while playing the instrument to set the desired listening level.

Handling caution

- Do not insert a finger or hand in any gaps on the instrument.
- Never insert or drop paper, metallic, or other objects into the gaps on the panel or keyboard. This could cause physical injury to you or others, damage to the instrument or other property, or operational failure.
- Do not rest your weight on, or place heavy objects on the instrument, and do not use excessive force on the buttons, switches or connectors.
- Do not use the instrument/device or headphones for a long period of time at a high or uncomfortable volume level, since this can cause permanent hearing loss. If you experience any hearing loss or ringing in the ears, consult a physician.

Yamaha cannot be held responsible for damage caused by improper use or modifications to the instrument, or data that is lost or destroyed.

Always turn the power off when the instrument is not in use.

Even when the [0] (Standby/On) switch is in standby status (display is off), electricity is still flowing to the instrument at the minimum level.

When you are not using the instrument for a long time, make sure you unplug the power cord from the wall AC outlet.

NOTICE

To avoid the possibility of malfunction/ damage to the product, damage to data, or damage to other property, follow the notices below.

■ Handling

- Do not connect this product to public Wi-Fi and/or Internet directly. Only connect this product to the Internet through a router with strong password-protections. Consult your router manufacturer for information on security best practices.
- Do not use the instrument in the vicinity of a TV, radio, stereo equipment, mobile phone, or other electric devices. Otherwise, the instrument, TV, or radio may generate noise.
- When you use the instrument along with an app on your smart device such as a smartphone or tablet, we recommend that you set Wi-Fi or Bluetooth to on after enabling “Airplane Mode” on that device in order to avoid noise caused by communication.
- Do not expose the instrument to excessive dust or vibrations, or extreme cold or heat (such as in direct sunlight, near a heater, or in a car during the day) to prevent the possibility of panel disfiguration, damage to the internal components or unstable operation. (Verified operating temperature range: 5° – 40°C, or 41° – 104°F.)
- Do not place vinyl, plastic or rubber objects on the instrument, since this might discolor the panel or keyboard.

■ Maintenance

- When cleaning the instrument, use a soft and dry/slightly damp cloth. Do not use paint thinners, solvents, alcohol, cleaning fluids, or chemical-impregnated wiping cloths.
- During extreme changes in temperature or humidity, condensation may occur and water may collect on the surface of the instrument. If water is left, the wooden parts may absorb the water and be damaged. Make sure to wipe any water off immediately with a soft cloth.

■ Saving data

- Recorded Song and edited Song/Style/Voice/MIDI setup data, etc. are lost when you turn off the power to the instrument. This also occurs when the power is turned off by the Auto Power Off function (page 17). Save the data to the instrument, or to USB flash drive (page 26).
- You can back up the data and settings of this instrument to the USB flash drive as a backup file (page 33), as well as restore a backup file to the instrument. To protect against data loss due to some failure, an operation mistake, etc., save your important data to a USB flash drive.
- To protect against data loss through USB flash drive damage, we recommend that you save your important data onto spare USB flash drive or an external device such as a computer as backup data.

Information

■ About copyrights

- Copying of the commercially available musical data including but not limited to MIDI data and/or audio data is strictly prohibited except for your personal use.
- This product incorporates and bundles contents in which Yamaha owns copyrights or with respect to which Yamaha has license to use others’ copyrights. Due to copyright laws and other relevant laws, you are NOT allowed to distribute media in which these contents are saved or recorded and remain virtually the same or very similar to those in the product.
 - * The contents described above include a computer program, Accompaniment Style data, MIDI data, WAVE data, voice recording data, a score, score data, etc.
 - * You are allowed to distribute medium in which your performance or music production using these contents is recorded, and the permission of Yamaha Corporation is not required in such cases.

■ About functions/data bundled with the instrument

- Some of the preset songs have been edited for length or arrangement, and may not be exactly the same as the original.
- This device is capable of using various types/formats of music data by optimizing them to the proper format music data for use with the device in advance. As a result, this device may not play them back precisely as their producers or composers originally intended.
- The bitmap fonts used in this instrument have been provided by and are the property of Ricoh Co., Ltd.

■ About this manual

- The illustrations and displays as shown in this manual are for instructional purposes only, and may appear somewhat different from those on your instrument.
- The letters at the end of the model name (such as “B,” “WH”) indicate the color of the instrument. Since they simply indicate the appearance, these letters are omitted in this manual.
- Windows is a registered trademark of Microsoft® Corporation in the United States and other countries.
- The Bluetooth® word mark and logos are registered trademarks owned by Bluetooth SIG, Inc. and any use of such marks by Yamaha Corporation is under license.



- The company names and product names in this manual are the trademarks or registered trademarks of their respective companies.

About the Manuals

This instrument has the following documents and instructional materials.

Included Documents



Owner's Manual (this book)

Explains the basic operations and functions of this instrument. Please read this manual first.

Online Materials (Downloadable from the web)



Reference Manual (only in English, German, French and Spanish)

Explains advanced features of the instrument, not explained in the Owner's Manual. For example, you can learn how to create original Styles or Songs, or find detailed explanations of specific parameters. Each chapter in this manual corresponds to the relevant chapters in the Owner's Manual.



Data List

Contains various important preset content lists such as Voices, Styles, etc., as well as MIDI-related information of this instrument.



Smart Device Connection Manual

Explains how to connect the instrument to a smart device such as smartphone or tablet, etc.



Computer-related Operations

Includes instructions on connecting this instrument to a computer, and operations related to transferring files and MIDI data.

To obtain these manuals, access the Yamaha Downloads, enter the model name for searching the desired files.

Yamaha Downloads

<https://download.yamaha.com/>

Included Accessories

- Owner's Manual (this book)
- Online Member Product Registration
- AC adaptor*/ power cord*
- Music rest
- Footswitch

* May not be included depending on your area. Check with your Yamaha dealer.

Contents

PRECAUTIONS	4
NOTICE.....	6
Information	6
About the Manuals.....	7
Included Accessories.....	7
Welcome to the new DGX!	10
Panel Controls and Terminals	12
Top Panel	12
Rear Panel	14
Starting Up	16
Power Supply	16
Turning the Power On/Off	16
Adjusting the Master Volume	17
Making Basic Settings	18
Basic Operations	19
Display-based Controls	19
Messages Shown in the Display.....	22
Calling Up the Desired Display Instantly — Direct Access	22
Main Display Configuration	23
File Selection Display Configuration.....	24
File Management.....	26
Entering Characters	31
Data Backup	33
Resetting to the Factory-programmed Settings (Initializing).....	34
1 Piano Room – Enjoying the Piano Performance –	35
Playing a Piano Performance in the Piano Room.....	35
Making the Detailed Settings in the Piano Room.....	36
Recording your Performance in the Piano Room	37
2 Voices – Playing the keyboard with various sounds –	38
Playing Preset Voices.....	38
Calling up the Appropriate Settings for Piano Performance (Piano Reset).....	41
Playing Realistic Resonance-enhanced Piano Sounds (VRM Voices).....	41
Playing Super Articulation Voices	42
Setting the Touch Response of the Keyboard.....	43
Using the Metronome.....	44
Changing the Pitch of the Keyboard	44
Applying Voice Effects	45
3 Styles – Playing Rhythm and Accompaniment –	48
Playing a Style with the Auto Accompaniment	48
Operating Style Playback.....	50

Playing in Unison or Adding Accents to Style Playback (Unison & Accent).....	54
Changing the Chord Fingering Type.....	56
Changing the Split Points.....	58
4 Songs – Playing, Practicing and Recording Songs –	60
Playback of Songs.....	60
Displaying Music Notation (Score).....	63
Displaying Lyrics.....	64
Turning Each Channel of the Song On/Off.....	65
One-handed Practice with the Guide Function.....	65
Repeat Playback.....	67
Recording Your Performance.....	68
5 USB Audio Player/Recorder – Playback and Recording Audio Files –	72
Playing Back Audio Files (USB Audio Player).....	72
Recording Your Performance as Audio (USB Audio Recorder).....	75
6 Microphone – Connecting a Microphone and Singing Along with Your Performance –	77
Connecting a Microphone.....	77
Using the Talk Function.....	78
7 Registration Memory/Playlist – Saving and Recalling Custom Panel Setups –	80
Saving and Recalling Custom Panel Setups with Registration Memory.....	81
Using Playlists to Manage a Large Repertoire of Panel Setups.....	84
8 Mixer – Editing the Volume and Tonal Balance –	88
Basic Procedure.....	88
9 Connections – Using Your Instrument with Other Devices –	91
Connecting USB Devices ([USB TO DEVICE] terminal).....	91
Connecting to a Computer ([USB TO HOST] terminal).....	92
Connecting to a Smart Device ([AUX IN] jack/Bluetooth/[USB TO HOST] terminal/Wireless LAN) ...	94
Listening to Audio Playback by an External Device through the Instrument’s Speaker ([AUX IN] jack/Bluetooth/[USB TO HOST] terminal).....	95
Connecting Headphones or an External Speaker ([PHONES/OUTPUT] jack).....	98
Connecting a Microphone ([MIC INPUT] jack).....	98
Connecting a Foot Pedal ([AUX PEDAL] jack).....	99
Connecting a Pedal Unit ([PEDAL UNIT] jack).....	99
10 Menu – Making Global Settings and Using Advanced Features –	100
Basic Procedure.....	100
Function List.....	101
Troubleshooting	103
Specifications	106
Compatible Format.....	108
Index	109

Welcome to the new DGX!

The DGX-670 is equipped with a color display and has many advanced features that enhance your musical enjoyment and expand your creative and performance possibilities. Let's take a look...

Authentic piano sound

This instrument features gorgeous piano Voices, created with samples of the Yamaha CFX flagship concert grand piano. This instrument also features VRM which accurately recreates the acoustic resonance of a grand piano, which changes subtly by the timing and strength of the player's touch and pedal operation. This enables expression of even the most delicate performance nuances and responds minutely to your pedal use and key playing. The Piano Room features provide even greater piano performance enjoyment. Piano Room lets you select the desired piano type as well as different room ambiances—enabling a complete, realistic piano experience, as if you were playing an actual piano.

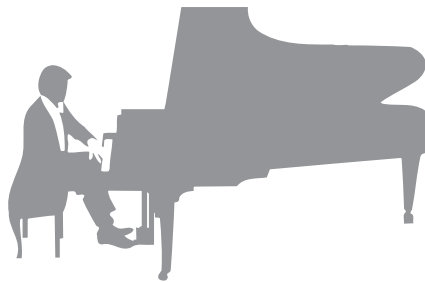

▶▶▶ Page 35

Performing in various music genres

Naturally, this instrument provides many realistic piano Voices for your playing enjoyment. But it also features a wide variety of authentic instruments, both acoustic and electronic, including organ, guitar, sax, and others used in many music genres—letting you convincingly perform in any desired music style. Moreover, the special Super Articulation Voices realistically recreate many of the performance techniques and characteristic sounds generated when an artist plays an instrument. The result is superbly detailed expression—such as the realistic sound of finger slides on guitar, and the expressive breath noises of saxophone and other wind instruments.

▶▶▶ Page 38

Full Backing Band Accompaniment

Even if you're playing alone, the DGX can put an entire backing band behind you! By simply playing the keyboard, chords are automatically detected and they trigger the auto accompaniment backing (Style function). Select an accompaniment Style—such as pop, jazz, Latin, and various other music genres in the world—and let the DGX be your complete backing band! You can change arrangements on the fly, instantly selecting different rhythm variations and breaks in real time, including Intro, Ending, and Fill-in, during your performance.



▶▶▶ Page 48

Audio playing and recording

Audio files (WAV format) saved to a USB flash drive can be played back on the instrument. You can also record your performance as audio files (WAV format) to a USB flash drive—making it easy to edit your recordings on computer as desired, and share them over the Internet.

▶▶▶ Page 72



Lesson features with Score display

The Lesson features are a fun way to learn and master Songs, with notation shown on the display. For example, when you practice the right-hand part, the playback of the left part and other parts will wait for you to play the notes correctly. This allows you to practice melodies and phrases smoothly—even if you are a beginner.

▶▶▶ Page 65

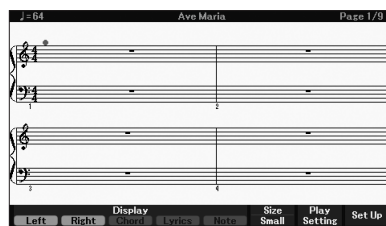

Sing along with Song playback or your own performance

Since a microphone can be connected to this instrument and Song lyrics can be shown on the display, you can enjoy singing along with your keyboard performance or along with Song playback. Moreover, you can apply various effects such as chorus to your singing voice. You can also cancel the vocal part on audio recordings, letting you sing along with (or instead of!) your favorite artists and groups, and enjoy performing even more.

▶▶▶ Page 77



Playing back the audio data wirelessly—Bluetooth Audio function

The audio data in a Bluetooth-equipped device such as a smartphone can be played back through the DGX-670's built-in speakers. You can enjoy playing or singing along with the audio data, or simply listening to your favorite music.

▶▶▶ Page 96



*Depending on the country in which you purchased the product, the instrument may not have Bluetooth capability.

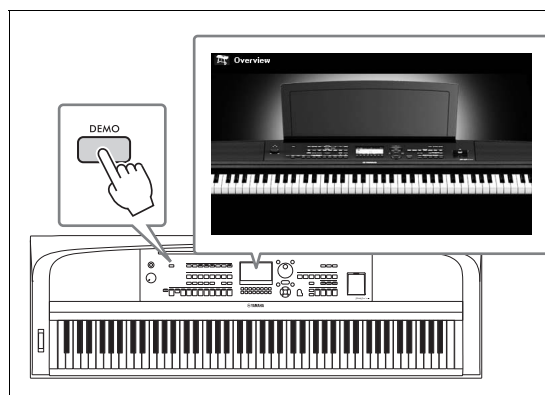

Want to learn more about the DGX-670's features?

Press the [DEMO] button and start the demonstration!

To stop the demonstration, press the [EXIT] button located at right of the display.

Panel Controls and Terminals

Top Panel

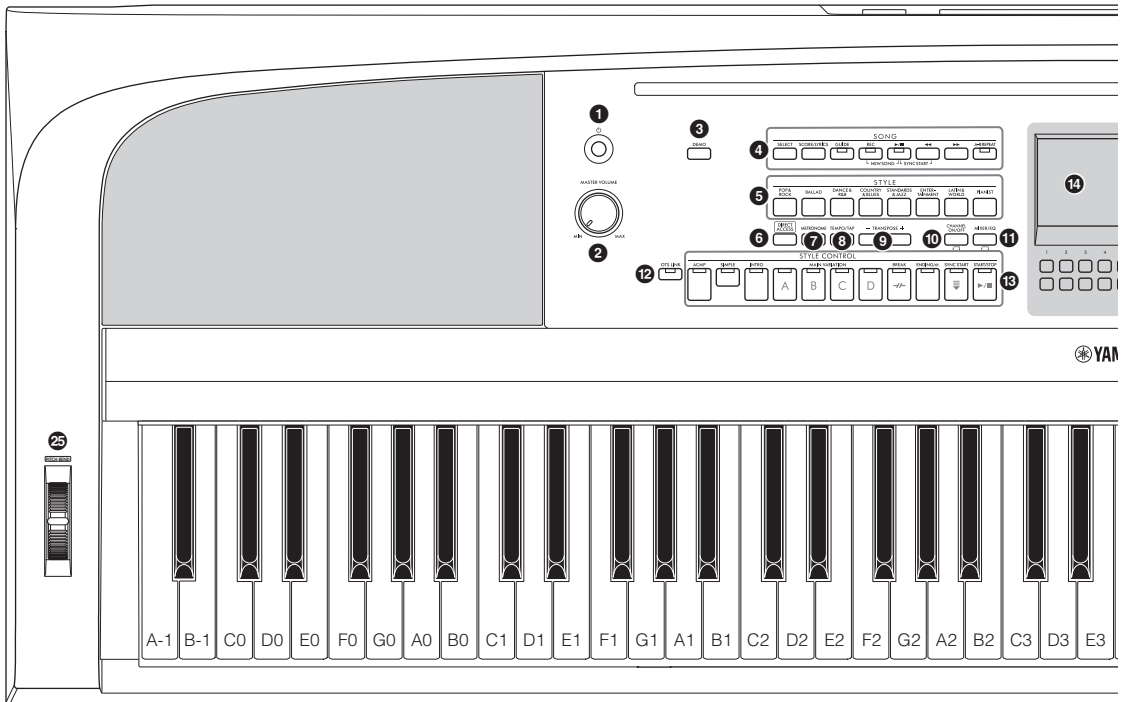

- 1** [⏻] (Standby/On) switch page 16
Turns on the instrument's power or sets to standby.
- 2** [MASTER VOLUME] dial page 17
Adjusts the overall volume.
- 3** [DEMO] button..... page 11
Plays the Demos.
- 4** SONG related buttons..... page 60
For selecting Songs and controlling Song playback.
- 5** STYLE category selection buttons..... page 48
For selecting a Style category.
- 6** [DIRECT ACCESS] button..... page 22
Instantly calls up the desired display with just a single additional button press.
- 7** [METRONOME] button page 44
Turns the metronome on or off.
- 8** [TEMPO/TAP] button page 52
Controls the tempo for Style, Song and Metronome playback.
- 9** TRANSPOSE [-]/[+] buttons page 44
Transposes the entire pitch of the instrument in semitone steps.
- 10** [CHANNEL ON/OFF] button pages 53, 65
Calls up settings for turning Style/Song channels on or off.
- 11** [MIXER/EQ] button page 88
Calls up various settings for the keyboard, Style and Song parts.
- 12** [OTS LINK] button page 52
Turns on/off the OTS Link function.
- 13** STYLE CONTROL buttons page 48
Controls Style playback.
- 14** LCD and related controls page 19
Indicates the current panel settings and allows you to select or change the settings.
- 15** [MENU] button..... page 100
Lets you make advanced settings and create your original Styles and Songs.

If your instrument is equipped with Bluetooth functionality (page 96), the Bluetooth logo is printed on the panel button. Depending on the country in which you purchased the product, the instrument may not have Bluetooth capability.



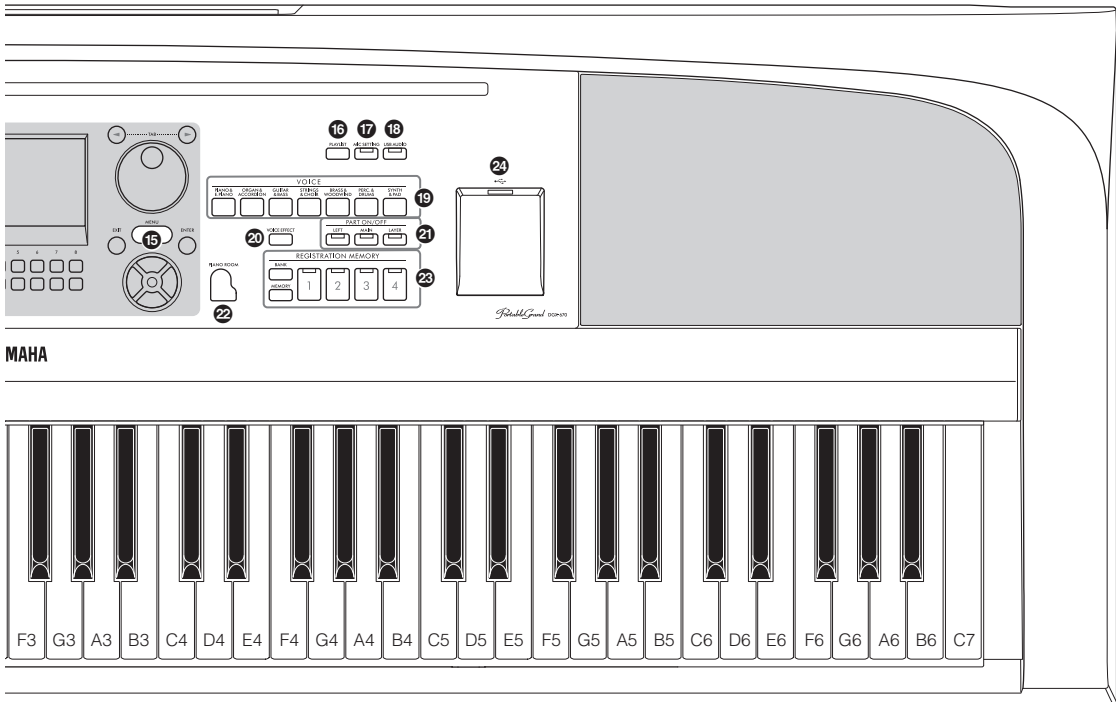

- 16 [PLAYLIST] button..... page 80**
Calls up the Playlist display in which you can manage your repertoire.
- 17 [MIC SETTING] button page 77**
Calls up the display from which you can make settings for the microphone.
- 18 [USB AUDIO] button page 72**
Calls up the display for playing back audio files in the connected USB flash drive and recording your performance to the USB flash drive in audio format.
- 19 VOICE category selection buttons page 38**
For selecting a Voice category.
- 20 [VOICE EFFECT] button page 45**
Applies various effects to the keyboard performance.
- 21 PART ON/OFF buttons..... page 38**
Turns the keyboard part on or off.
- 22 [PIANO ROOM] button page 35**
Instantly calls up the optimum piano-related settings for playing the instrument simply as a piano.
- 23 REGISTRATION MEMORY buttons... page 80**
Registers and recalls panel setups.

- 24 [USB TO DEVICE] terminal page 91**
For connecting a USB flash drive or USB wireless LAN adaptor.
- 25 [PITCH BEND] wheel page 45**
Bends the pitch of the keyboard played sound up or down.

Panel Setup (Panel Settings)
By using the controls on the panel, you can make various settings as described here. These settings of the instrument are together referred to as “panel setup” or “panel settings” in this manual.

Rear Panel

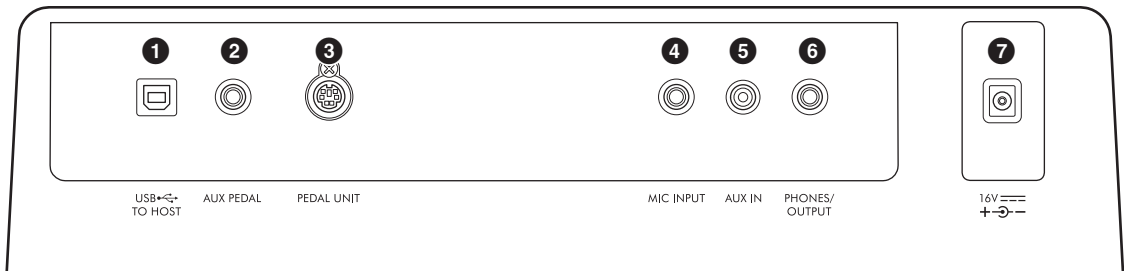

- ❶ [USB TO HOST] terminal page 92
For connecting to a computer or smart device such as smartphone or tablet.
- ❷ [AUX PEDAL] jack see below
For connecting the included footswitch or separately sold foot pedals.
- ❸ [PEDAL UNIT] jack..... page 15
For connecting a separately sold pedal unit.
- ❹ [MIC INPUT] jack page 77
For connecting a microphone.
- ❺ [AUX IN] jack page 95
For connecting an external audio device, such as a portable audio player.

- ❻ [PHONES/OUTPUT] jack..... page 98
For connecting headphones or an external devices, such as speakers.
- ❼ DC IN jack page 16
For connecting the AC adaptor.

⚠ CAUTION

Before connecting the instrument to other electronic components, turn off the power of all the components. Also, before turning any components on or off, make sure to set all volume levels to minimum (0). Otherwise, damage to the components, electrical shock, or even permanent hearing loss may occur.

Attaching the Music Rest

Insert the music rest into the slots as shown.

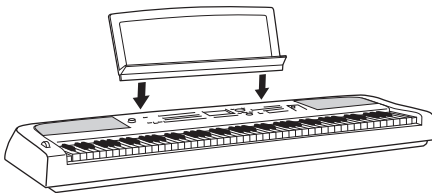

Connecting a Footswitch

Connect the included footswitch to the [AUX PEDAL] jack. Other separately sold foot pedals (FC3A, FC4A or FC5) can also be connected to this jack. By default, the sustain function is assigned.

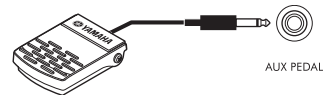

NOTE

- Make sure that the power is off when connecting or disconnecting the footswitch.
- Do not press the footswitch while turning the power on. Doing this changes the recognized polarity of the footswitch, resulting in reversed operation.

Assigning a function to each pedal

Various functions can be assigned to each pedal connected to the [AUX PEDAL] jack or the [PEDAL UNIT] jack — including start/stop of Song playback and controlling Super Articulation Voices. These can be set on the *Pedal* tab of the *Controller* display called up via the [MENU] button (page 100).

Using a Keyboard Stand and Pedal Unit (Sold Separately)

A separately sold LP-1B/LP-1WH pedal unit can be connected to the [PEDAL UNIT] jack. When connecting the pedal unit, make sure to also assemble the unit on the separately sold L-300B/L-300WH keyboard stand. The L-300B/L-300WH keyboard stand is designed to be used for multiple models. When assembling the keyboard stand for the DGX-670, make sure to use the screw holes indicated by “B” on the metal brackets of the stand. For details, refer to the assembly manual of the stand.

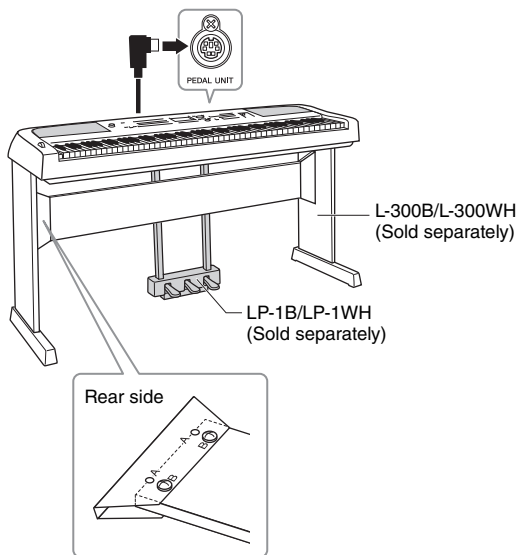

NOTE

- Make sure that the power is off when connecting or disconnecting the pedal unit.
- Do not press the pedals while turning the power on. Doing this changes the recognized polarity of the pedals, resulting in reversed operation.

Half Pedal function (for FC3A and LP-1B/LP-1WH)

The FC3A and the right pedal of the LP-1B/LP-1WH have a Half Pedal function which allows you to use half-damper techniques, in which the damper is pressed somewhere between all the way down and all the way up. In this half-damper state (on a real piano), the damper felts only partially mute the strings. The Half Pedal function lets you delicately and expressively control the damper muting, and create subtle nuances in your performance, by finely controlling the point at which pressure on the pedal affects the damper muting. The point is called “Half Pedal Point” and can be set on the *Pedal* tab of the *Controller* display called up via the [MENU] button (page 100).

Pedal Unit Functions

By default, the following functions are assigned to each pedal.

■ Damper Pedal (Right)

Pressing this pedal will sustain notes longer. Releasing this pedal immediately stops (damps) any sustained notes.

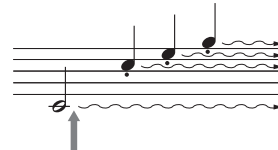

If you press and hold the damper pedal here, all the notes shown will be sustained.

When you select a VRM Voice (page 41), pressing this pedal activates the VRM to accurately recreate the unique resonance of an acoustic grand piano’s soundboard and strings.

■ Sostenuto Pedal (Center)

If you play a note or notes on the keyboard and press the sostenuto pedal while the note(s) are held, those notes will sustain as long as you hold the pedal (as if the damper pedal had been pressed) but all subsequently played notes will not be sustained. This makes it possible to sustain a note or notes, for example, while other notes are played “staccato.”

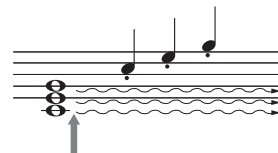

If you press and hold the sostenuto pedal here, only the notes held at this timing will be sustained.

■ Soft Pedal (Left)

The soft pedal reduces the volume and slightly changes the timbre of notes played while the pedal is pressed. The soft pedal will not affect notes that are already playing when it is pressed.

Starting Up

Power Supply

Connect the plugs of the AC adaptor in the order shown in the illustration.

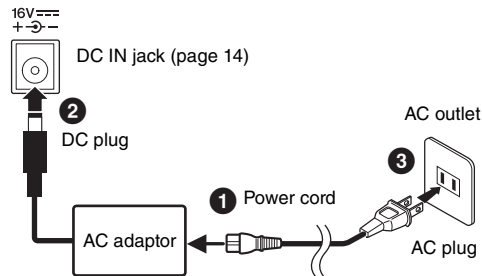

The shape of the plug and outlet differ depending on the locale.

⚠ WARNING

Use the specified AC adaptor (page 107) only. Using the wrong AC adaptor can result in damage to the instrument or overheating.

⚠ CAUTION

When setting up the product, make sure that the AC outlet you are using is easily accessible. If some trouble or malfunction occurs, immediately turn the power off and disconnect the plug from the outlet.

NOTE

When disconnecting the power cord, first turn off the power, and then follow this procedure in reverse order.

Turning the Power On/Off

- 1 Turn down the [MASTER VOLUME] dial to “MIN.”

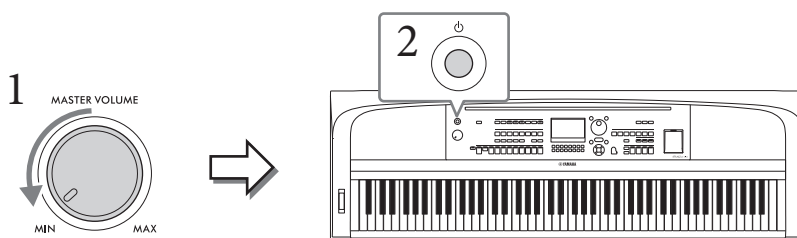

- 2 Press the [⏻] (Standby/On) switch to turn the power on.

After the Main display appears, adjust the volume as desired while playing the keyboard.

NOTICE

Do not attempt any other operations, such as pressing keys, buttons or pedals. Doing so may cause the instrument to malfunction.

- 3 After you finish using the instrument, turn off the power by pressing the [⏻] (Standby/On) switch for about a second.

CAUTION

Even when the [⏻] (Standby/On) switch is in standby status, electricity is still flowing to the instrument at the minimum level. Remove the electric plug from the outlet when the instrument is not to be used for extended periods of time, or during electrical storms.

NOTICE

While recording or editing, or while a message is displayed, the power cannot be turned off even if you press the [⏻] (Standby/On) switch. If you want to turn off the power, press the [⏻] (Standby/On) switch after recording, editing, or after the message has disappeared. If you need to force-quit the instrument, hold down the [⏻] (Standby/On) switch for longer than three seconds. Note that the force-quit operation might cause data loss and damage to the instrument.

Setting the Auto Power Off function

To prevent unnecessary power consumption, this instrument features an Auto Power Off function that automatically turns the power off if the instrument is not operated for a specified period of time. The amount of time that elapses before the power is automatically turned off is 30 minutes by default; however, you can change the setting. For details, refer to page 18.

NOTICE

Any data which is not saved via the Save operation will be lost if the power automatically turns off. Make sure to save your data before this happens.

■ Disabling Auto Power Off (simple method)

Turn the power on while holding down the lowest key on the keyboard. A message appears briefly, then the instrument starts up with the Auto Power Off function disabled.

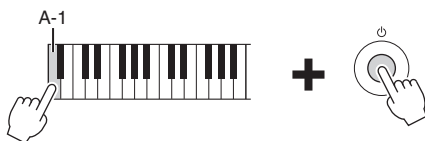

Adjusting the Master Volume

To adjust the volume of the entire keyboard sound, use the [MASTER VOLUME] dial while playing the keyboard.

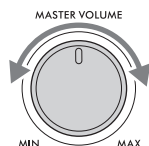

CAUTION

Do not use the instrument for a long period of time at a high or uncomfortable volume level, since this can cause permanent hearing loss.

Intelligent Acoustic Control (IAC)

IAC is a function which automatically adjusts and controls the sound quality according to the overall volume of the instrument. Even when the volume is low, it permits both low sounds and high sounds to be clearly heard. IAC Control affects only the sound output of the instrument speakers. You can turn the IAC function on or off, and set the depth, although the default setting for this function is on. This can be set on the *Config1* tab in the *Utility* display called up via the [MENU] button (page 100).

Making Basic Settings

As necessary, make basic settings for the instrument, such as the language shown on the display.

1 Call up the operation display.

1-1 Press the [MENU] button to call up the *Menu* display.

1-2 Use the Cursor buttons [▲][▼][◀][▶] to select *System*, and then press the [ENTER] button.

1-3 Press the TAB [◀] button to select the *Common* tab.

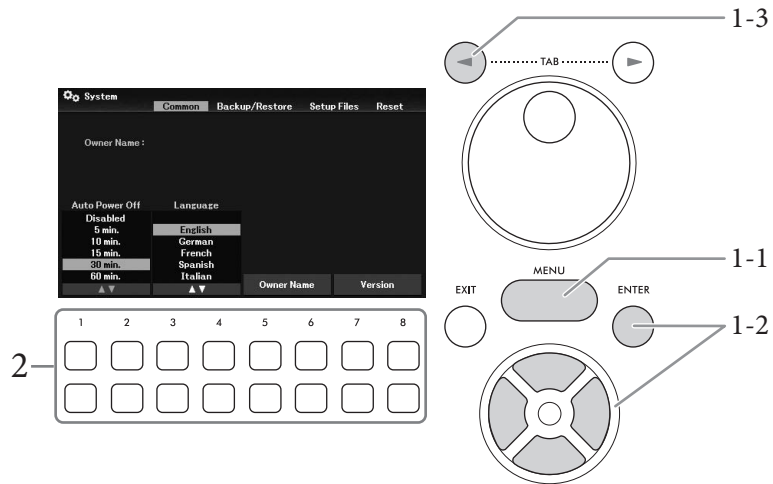

2 Use the [1▲▼] - [8▲▼] buttons to make the necessary settings.

[1▲▼]/ [2▲▼]	Auto Power Off	Determines the amount of time that elapses before the power is automatically turned off by the Auto Power Off function (page 17). To disable Auto Power Off, select Disabled here.
[3▲▼]/ [4▲▼]	Language	Determines the language (English, German, French, Spanish and Italian are available) used in the display for messages.
[5▲▼]/ [6▲▼]	Owner Name	Lets you input your name which appears in the opening display (called up when the power is turned on). For instructions on entering characters, refer to page 31.
[7▲▼]/ [8▲▼]	Version	Calls up the firmware version of this instrument.

To return to the previous display, press the [EXIT] button.

Basic Operations

Display-based Controls

The LCD provides comprehensive at-a-glance information on all current settings. The displayed menu or parameters can be selected or changed by the controls around the LCD.

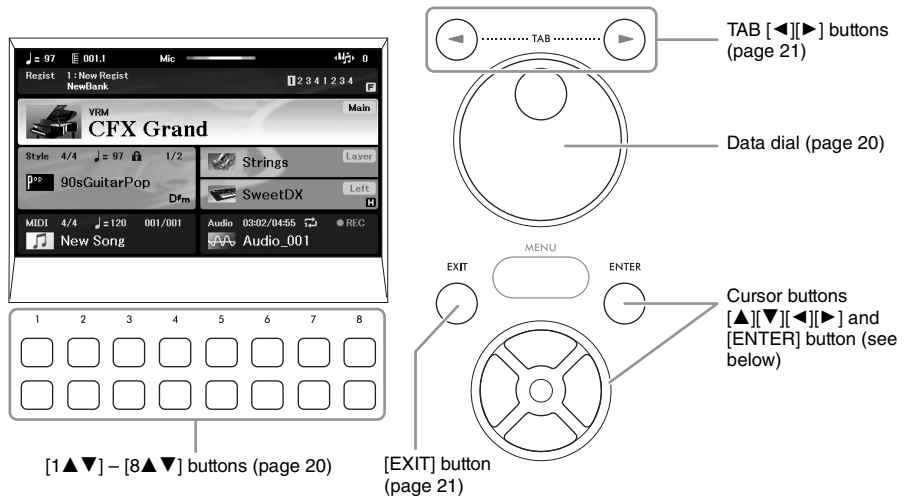

Cursor buttons [▲][▼][◀][▶] and [ENTER] button

These buttons are used to move the on-screen cursor. In this manual, the upper and lower buttons are described as [▲] [▼] and the left and right buttons as [◀] [▶]. There are two types of display. One is the type in which the item is selected (and called up) only by moving the cursor, and the other is the type in which you need to press the [ENTER] button after moving the cursor to actually call up the item.

■ Example 1

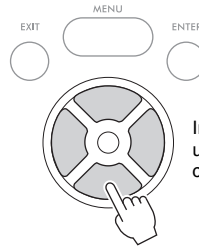

In the File Selection display (page 24), use the Cursor buttons to select and call up the file.

■ Example 2

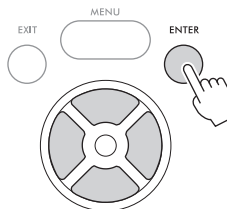
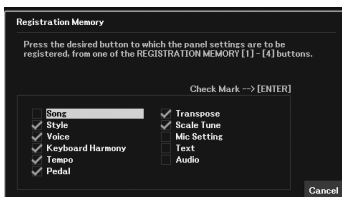

In the Menu display (page 100) and other setting displays, use the Cursor buttons to move the cursor, and then press the [ENTER] button to actually select the item.

[1▲▼] – [8▲▼] buttons

The [1▲▼] – [8▲▼] buttons are used to make selections or adjust settings (up or down correspondingly) for functions shown directly above them. In this manual, the upper buttons are described as [▲] and the lower buttons as [▼].

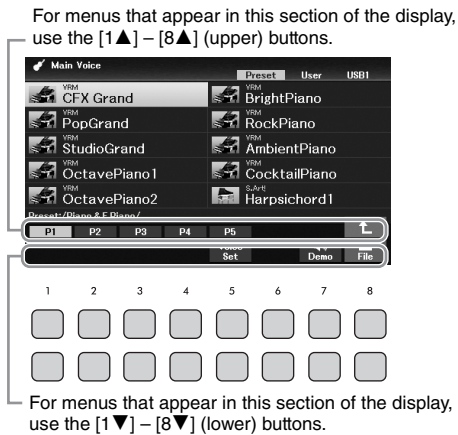

For list menus that appear, use the [1▲▼] – [8▲▼] buttons to select the desired item.

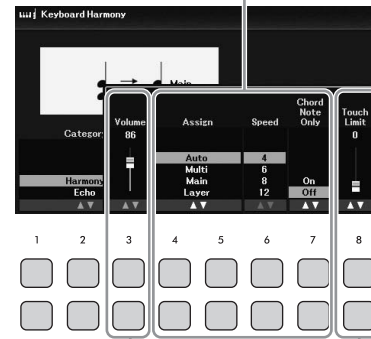

For parameters that appear in slider (or knob) form, use the [1▲▼] – [8▲▼] buttons to adjust the value.

When setting parameters, you can reset the parameter to the default value by pressing both [▲] and [▼] buttons of the same number simultaneously.

Data dial

Depending on the selected display, the Data dial can be used in the following two ways.

■ Adjusting parameter values

You can conveniently use the Data dial in tandem with the [1▲▼] – [8▲▼] buttons to adjust parameters indicated in the display.

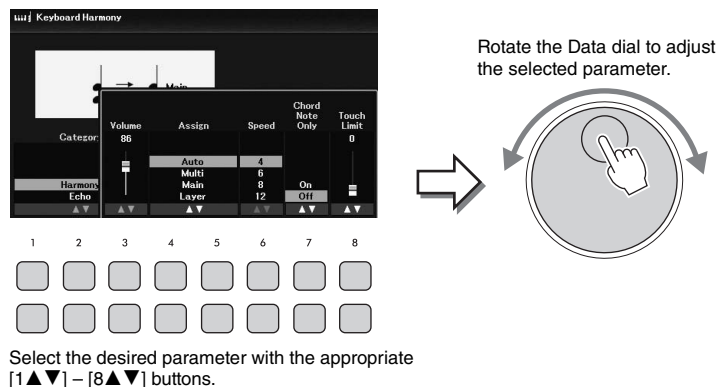

This convenient technique also works well with pop-up parameters such as Tempo and Transpose. Simply press the appropriate button (ex., [TEMPO/TAP]), and then rotate the Data dial to set the value.

■ Selecting files (Voice, Style, Song, and so on)

The operation by using the Data dial is almost same as that of the Cursor buttons. After calling up the File Selection displays, rotate the Data dial to move the cursor, and then press the [ENTER] button to actually select and call up the file.

In most procedures when selecting the file or item described throughout this Owner's Manual, the Cursor buttons [▲][▼][◀][▶] are used for simple selection, though other methods may also be used.

TAB [◀][▶] buttons

These buttons are used mainly to change the pages of displays that have “tabs” at the top.

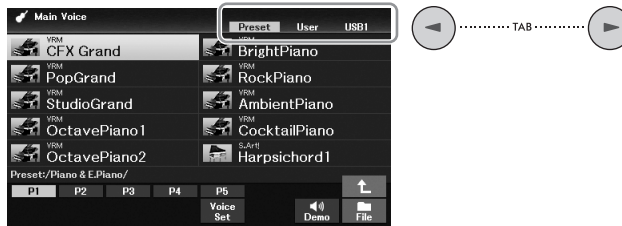

[EXIT] button

Pressing the [EXIT] button returns to the previously indicated display. Pressing the [EXIT] button several times returns to the default Main display (page 23).

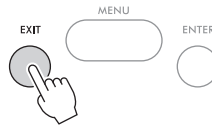

Instruction Conventions in this Manual

Throughout this manual, instructions with multiple steps are given in convenient shorthand, with arrows indicating the proper sequence.

Example:

[MENU] → Cursor buttons [▲][▼][◀][▶] **Controller**, [ENTER] → TAB [▶] **Setting** → Cursor button [▲] **1 Touch Response**.

The example above describes a four-step operation:

- 1) Press the [MENU] button.
- 2) Use the Cursor buttons [▲][▼][◀][▶] to select **Controller**, and then press the [ENTER] button.
- 3) Press the TAB [▶] buttons to select the **Setting** tab.
- 4) Press the Cursor button [▲] to select **1 Touch Response**.

Messages Shown in the Display

A message (information or confirmation dialog) sometimes appears on the screen to facilitate operation. When the message appears, press one of the [1▲▼] – [8▲▼] buttons corresponding to the message.

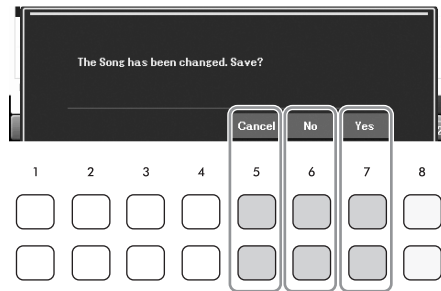

Calling Up the Desired Display Instantly — Direct Access

With the convenient Direct Access function, you can instantly call up the desired display — with just a single additional button press. Refer to the *Direct Access Chart* in the Data List on the website for a list of the displays that can be called up with the Direct Access function.

1 Press the [DIRECT ACCESS] button.

A message appears in the display prompting you to press the appropriate button.

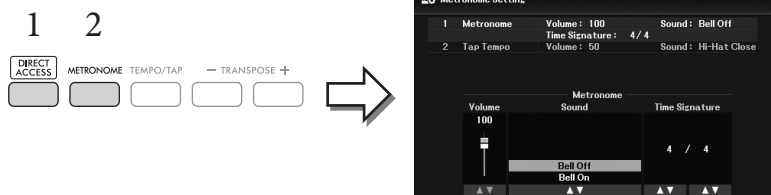

2 Press the button (or move the [PITCH BEND] wheel or connected pedal) corresponding to the desired setting display to instantly call up that display.

For example, pressing the [METRONOME] button calls up the display in which the time signature, volume and sound of the metronome can be set.

Main Display Configuration

The display that appears when the power is turned on is the Main display. This display shows the current basic settings such as the currently selected Voice and Style, allowing you to see them at a single glance. The Main display is the one you'll usually see when you play the keyboard.

The File Selection display (page 24) of Style, Song, Voice or Registration Memory Bank can also be called up from this display. To do this, use the Cursor buttons [▲][▼][◀][▶] to select the desired item, and then press the [ENTER] button.



1 Voice name

Displays the Voice names currently selected for the Main, Layer and Left parts (page 38).

NOTE

When the Left Hold function (page 46) is on, an "H" indication appears at the right corner of the Left part.

2 Style name and related information

Displays the currently selected Style name, time signature and tempo (page 48).

When the [ACMP] button is turned on, the detected chord during your keyboard performance will be displayed. When the Song containing the chord data is played back, the current chord name will be displayed.

3 Song (MIDI file) name and related information

Displays the currently selected Song name, time signature and tempo (page 60).

4 Audio file name and related information

Displays information for the selected audio file in the connected USB flash drive (page 72), including the elapsed playback time, file name and Repeat mode icon. While recording, "REC" is shown.

5 Registration Memory Bank name and related information

Displays the currently selected Registration Memory Bank name and current Registration number (page 81).

When the Registration Sequence is on, the programmed numbers are shown. The function lets you call up the four setups in any order you specify, by simply using the TAB [◀][▶] buttons or the pedals. For details, refer to the Reference Manual on the website, Chapter 7.

NOTE

When the Freeze function (page 83) is on, an "F" indication appears at the right corner.

6 Tempo

Displays the current tempo in Style playback or Song playback.

7 Bar/Beat

Displays the current position (bar/beat) in Style playback or Song playback.

8 Microphone indicator

Indicates the input level of the connected microphone (page 77).

9 Transpose

Displays the amount of transposition in semitone units (page 44).

File Selection Display Configuration

The File Selection display is for selecting Voice, Styles, and other data (files). The File Selection display appears when you press one of the VOICE or STYLE category selection buttons, SONG [SELECT] button, etc.

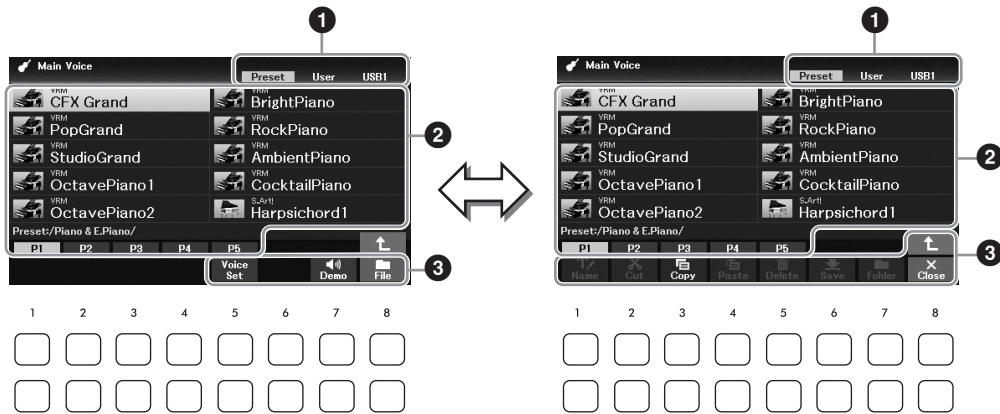

1 Location (drive) of data

- **Preset**.... Location where pre-programmed (preset) data is stored.
- **User**..... Location where recorded or edited data is saved.
- **USB1**..... Location where data on USB flash drive is saved. This appears only when a USB flash drive is connected to the [USB TO DEVICE] terminal.

NOTE

Before using a USB flash drive, be sure to read "Connecting USB Devices" on page 91.

2 Selectable data (files)

The files that can be selected on this display are shown. If more than 10 files exist, the page numbers (P1, P2 ...) are shown below the files. Pressing one of the [1▲] – [7▲] buttons corresponding to the page numbers changes the display page. For pages that follow, "→" appears, and for previous pages, "←" appears.

3 File/Close

At the bottom of the File Selection display, you can toggle the indication between **File** and **Close** by pressing the [8▼] button. Pressing the [8▼] button while **File** is shown calls up the File Management menu (page 26), while pressing the [8▼] button while **Close** is shown closes the File Management menu and calls up the function names related to the current file (Voice, Style, Song, etc.).

Calling up a higher level folder

When there are files in a folder, an up arrow is shown at the lower right of the display, allowing you to call up the higher level folder by pressing the [8▲] button.

Example of the Preset Voice Selection display

The preset Voices are categorized and contained in appropriate folders.

The next highest level (in this case, folder) is shown. Each folder shown in this display contains appropriately categorized Voices.

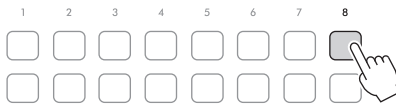

Press the [8▲] button to call up the next higher level folder.

This display shows the Voices in a folder.

File Management

You can save, name, copy, move, delete files, and you can create folders to manage the files with the buttons located lower area in the File Selection display. For information on the File Selection display, refer to page 24.

NOTE

Before using a USB flash drive, be sure to read “Connecting USB Devices” on page 91.

Saving a File

You can save your original data (such as Songs you’ve recorded) as a file to the instrument or USB flash drive.

- 1 In the File Selection display, select the appropriate tab (*User* or *USB1*) to which you want to save the data by using the TAB [◀][▶] buttons.

If you want to save the data within an existing folder, also select the folder here.

NOTE

- Files cannot be saved to the *Preset* tab.
- The maximum total number of files/folders which can be saved to the *User* tab differs depending on the file size and the length of the file/folder names.

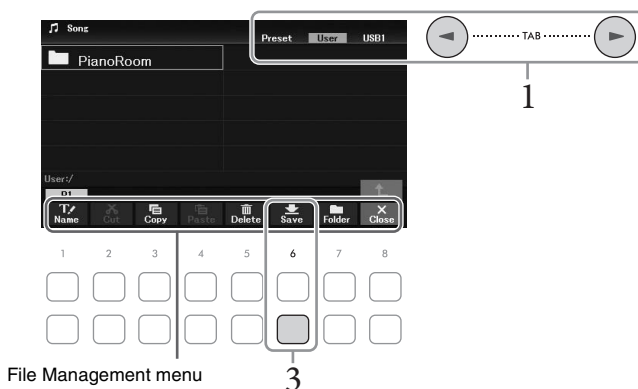

- 2 Make sure that the File Management menu is shown at the bottom of the display.

If the menu is not shown, press the [8▼] (*File*) button to call it up.

- 3 Press the [6▼] (*Save*) button.

The Character Entry window is called up.



NOTE

To cancel the Save operation, press the [8▼] (*Cancel*) button before step 5 below.

- 4 Enter the file name (page 31).

Even if you skip this step, you can rename the file at any time after saving it (page 28).

5 Press the [8▲] (OK) button to actually save the file.

If the file name already exists, a message appears asking you if you want to overwrite or not. If not, press one of the [6▲▼] (No) buttons and enter another name.

The saved file will be automatically located at the appropriate position among the files in alphabetical order.

Creating a New Folder

You can create folders to make it easier to find your original data.

1 In the File Selection display, select the appropriate tab (User or USB1) to which you want to create a new folder by using the TAB [◀][▶] buttons.

If you want to create a new folder within an existing folder, also select the folder here.

NOTE

- A new folder cannot be created in the *Preset* tab or the *PianoRoom* folder (page 37).
- The maximum number of files/folders which can be saved in a folder is 500.
- In the *User* tab, no more than three folder levels can be created. The maximum total number of files/folders which can be saved differs depending on the file size and the length of the file/folder names.

2 Make sure that the File Management menu is shown at the bottom of the display.

If the menu is not shown, press the [8▼] (File) button to call it up.

3 Press the [7▼] (Folder) button.

The Character Entry window is called up.

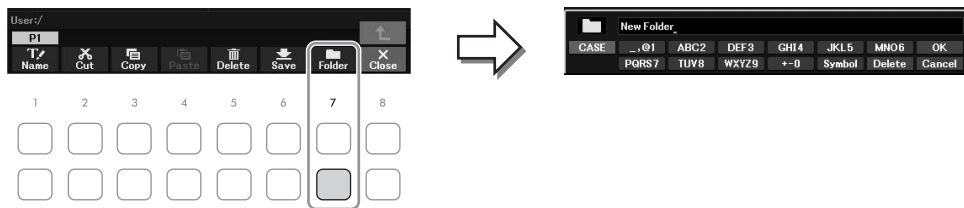

NOTE

To cancel creating a new folder, press the [8▼] (Cancel) button.

4 Enter the name of the new folder (page 31).

If the folder name already exists, a message appears asking you if you want to overwrite or not. If not, press one of the [6▲▼] (No) buttons and enter another name.

The created folder will be automatically located at the appropriate position among the folders in alphabetical order.

Renaming a File/Folder

You can rename files/folders.

NOTE

- Files and folders in the *Preset* tab cannot be renamed.
- The *PianoRoom* folder (page 37) cannot be renamed.

- 1 In the File Selection display, select the appropriate tab (*User* or *USB1*) to which you want to rename by using the TAB [◀][▶] buttons.**
- 2 Make sure that the File Management menu is shown at the bottom of the display.**
If the menu is not shown, press the [8▼] (*File*) button to call it up.
- 3 Press the [1▼] (*Name*) button.**
The window for the Rename operation appears at the bottom of the display.

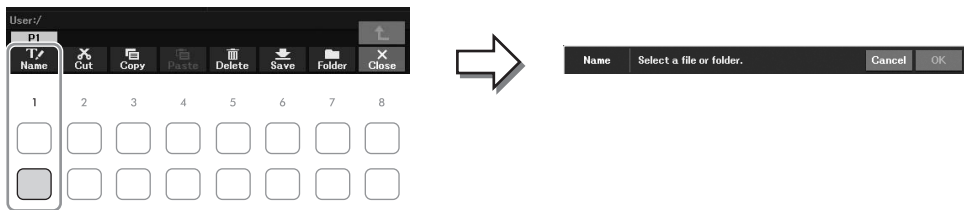

- 4 Move the cursor to the desired file/folder by using the Cursor buttons [▲][▼][◀][▶], and then press the [ENTER] button.**

NOTE

To cancel the Rename operation, press the [7▼] (*Cancel*) button.

- 5 Press the [8▼] (*OK*) button to confirm the file/folder selection.**

The Character Entry window is called up.

- 6 Enter the name of the selected file or folder (page 31).**

The renamed file/folder appears on the display at the appropriate position among the files in alphabetical order.

Copying or Moving Files

You can copy or cut files and paste them to another location (folder). You can also copy folders (but not move them) by using the same procedure.

NOTE

- Files in the *Preset* tab and the *PianoRoom* folder (page 37) cannot be moved.
- Protected Songs such as preset Songs copied to the *User* tab are indicated by "Prot. 1" above the Song name on the Song Selection display. These cannot be copied or moved to USB flash drives.

- 1 In the File Selection display, select the appropriate tab (*Preset*, *User* or *USB1*) which contains the file/folder you want to copy by using the TAB [◀][▶] buttons.**
- 2 Make sure that the File Management menu is shown at the bottom of the display.**
If the menu is not shown, press the [8▼] (*File*) button to call it up.
- 3 Press the [3▼] (*Copy*) button to copy or [2▼] (*Cut*) button to move.**
The window for the Copy/Cut operation appears at the bottom of the display.

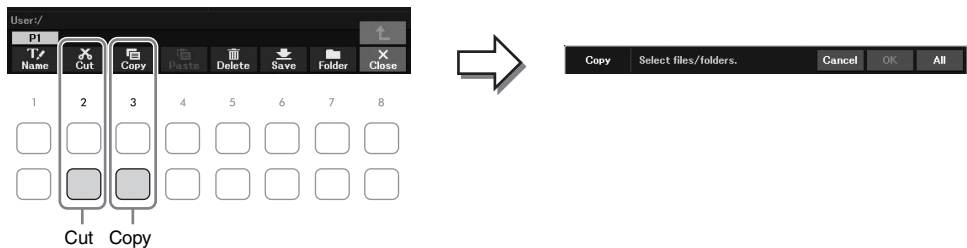

- 4 Move the cursor to the desired file/folder by using the Cursor buttons [▲][▼][◀][▶], and then press the [ENTER] button.**
Pressing the [ENTER] button selects (highlights) the file/folder. To cancel the selection, press the [ENTER] button again.
Press the [8▼] (*All*) button to select all files/folders indicated on the current display including the other pages. To cancel the selection, press the [8▼] (*All Off*) button again.

NOTE

To cancel the Copy/Move operation, press the [6▼] (*Cancel*) button.

- 5 Press the [7▼] (*OK*) button to confirm the file/folder selection.**
- 6 Select the destination tab (*User* or *USB1*) to paste the file/folder, by using the TAB [◀][▶] buttons.**
If necessary, select the destination folder by using the Cursor buttons [▲][▼][◀][▶], and then press the [ENTER] button.
- 7 Press the [4▼] (*Paste*) button to paste the file/folder selected in step 4.**
If the file/folder name already exists, a message appears asking you if you want to overwrite or not. If not, press one of the [6▲▼] (*No*) buttons and enter another name.
The pasted file/folder appears on the display at the appropriate position among the files in alphabetical order.

Deleting Files/Folders

You can delete individual or multiple files/folders.

NOTE

- Files in the *Preset* tab cannot be deleted.
- The *PianoRoom* folder (page 37) cannot be deleted.

- 1 In the File Selection display, select the appropriate tab (*User* or *USB1*) which contains the file/folder you want to delete by using the TAB [◀][▶] buttons.
- 2 Make sure that the File Management menu is shown at the bottom of the display. If the menu is not shown, press the [8▼] (*File*) button to call it up.
- 3 Press the [5▼] (*Delete*) button.

The window for the Delete operation appears at the bottom of the display.

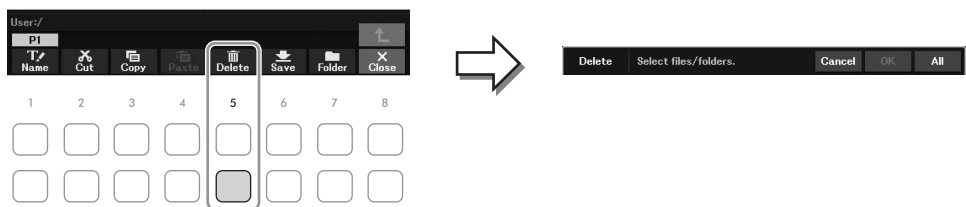

- 4 Move the cursor to the desired file/folder by using the Cursor buttons [▲][▼][◀][▶], and then press the [ENTER] button.

Pressing the [ENTER] button selects (highlights) the file/folder. To cancel the selection, press the [ENTER] button again.

Press the [8▼] (*All*) button to select all files/folders indicated on the current display including the other pages. To cancel the selection, press the [8▼] (*All Off*) button again.

NOTE

To cancel the Delete operation, press the [6▼] (*Cancel*) button.

- 5 Press the [7▼] (*OK*) button to confirm the file/folder selection.
- 6 Follow the on-display instructions.
 - **Yes:** Deletes the file/folder
 - **Yes All:** Deletes all selected files/folders
 - **No:** Leaves the file/folder as is without deleting
 - **Cancel:** Cancels the Delete operation

Entering Characters

This section covers how to enter characters for naming your files/folders, etc. Entering characters is done in the display shown below.

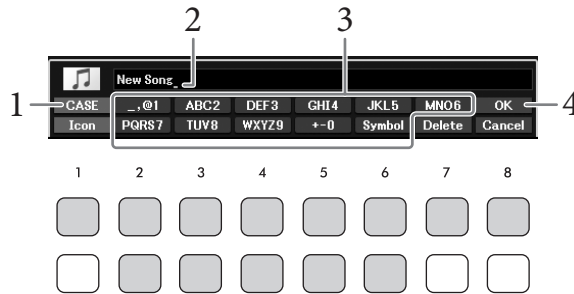

NOTE

- The following marks cannot be entered for a file/folder name: \ / : * ? " < > |
- File names or folder names can contain up to 50 characters.

- 1 Change the type of character by pressing the [1▲] button.**
 - **CASE:** Capital letters, numbers, marks
 - **case:** Lowercase letters, numbers, marks
- 2 Use the Data dial to move the cursor to the desired position.**
- 3 Press the [2▲▼] – [6▲▼] and [7▲] buttons, corresponding to the character you wish to enter.**

Several different characters are assigned to each button, and the characters change each time you press the button. To actually enter the selected character, move the cursor or press another character-input button. Alternately, you can wait for a short time and the character will be entered automatically.

For more information on entering characters, refer to “Other character-entry operations” on the page 32.

NOTE

To cancel the character-entering operation, press the [8▼] (Cancel) button.

- 4 Press the [8▲] (OK) button to actually enter the new name and return to the previous display.**

Other character-entry operations

■ Deleting characters

Move the cursor to the character you wish to delete by using the Data dial, and press the [7▼] (*Delete*) button. To delete all characters on the line at once, press and hold the [7▼] (*Delete*) button.

■ Entering marks or space

- 1 Press the [6▼] (*Symbol*) button to call up the mark list.
- 2 Use the Data dial to move the cursor to the desired mark or space, and then press the [8▲] (*OK*) button.

■ Selecting custom icons for files (shown at left of file name)

- 1 Press the [1▼] (*Icon*) button to call up the Icon Select pop-up.
- 2 Select the icon by using the Cursor buttons [▲][▼][◀][▶] or Data dial. The display includes several pages. Use the TAB [◀][▶] buttons to select the desired pages.
- 3 Press the [8▲] (*OK*) button to apply the selected icon.

NOTE

To cancel the operation, press the [8▼] (*Cancel*) button.

Data Backup

You can back up all data saved in the User drive (except protected Songs) and all settings of the instrument to a USB flash drive as a single file (extension: *bup*). The backup file can be restored to the instrument again, allowing you to recall the panel settings and performance data you created previously. For information on the settings that can be backed up, refer to the **Backup/Restore** column of the **Parameter Chart** in the Data List on the website.

NOTICE

Completing the backup/restore operation may take a few minutes. Do not turn off the power during backup or restoring. If you turn off the power during backup or restoring, data may be lost or damaged.

NOTE

- Before using a USB flash drive, be sure to read “Connecting USB Devices” on page 91.
- You can also back up files in the User drive such as Voice, Song and Registration Memory by copying them individually to a USB flash drive as desired. For instructions, refer to page 29.
- You can also back up System settings, MIDI settings and User Effect settings individually to the *Setup Files* tab on the *System* display below. For details, refer to the Reference Manual on the website, Chapter 10.

1 Connect a USB flash drive to the [USB TO DEVICE] terminal for the backup destination.

2 Call up the operation display.

[MENU] → Cursor buttons [▲][▼][◀][▶] **System**, [ENTER] → TAB [◀][▶] **Backup/Restore**

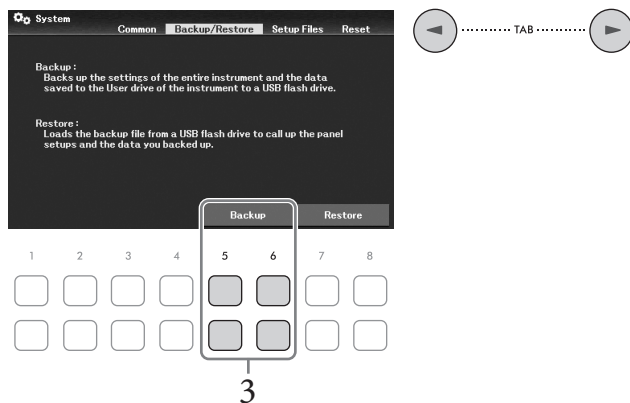

3 Use the [5▲▼]/[6▲▼] (**Backup**) buttons to save the data to the USB flash drive. When confirmation messages appear, follow the on-display instructions.

Restoring the Backup File

To do this, press the [7▲▼]/[8▲▼] (**Restore**) buttons in the **Backup/Restore** tab (see above). When confirmation messages appear, follow the on-display instructions. When the operation is completed, the instrument will be restarted automatically.

NOTICE

If any of the files (such as Songs or Styles) in the User drive of the instrument have the same name with the data contained in the backup file, the data are overwritten by restoring the backup file. Move or copy the files in the User drive of the instrument to USB flash drive before restoring (page 29).

Resetting to the Factory-programmed Settings (Initializing)

While holding the right-most key (C7) on the keyboard, turn the power on. This resets (or initializes) all of the settings (referred to as the System Setup parameters) to their factory default, with the exceptions of **Language** (page 18), **Owner Name** (page 18) and Bluetooth pairing information (page 96). Refer to the **Parameter Chart** in the Data List on the website for details about which parameters belong to System Setup.

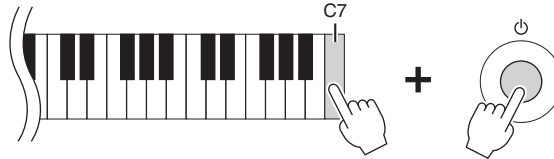

If you want to initialize only the Registration Memory settings (page 81), turn the power on while holding the B6 key.

NOTE

You can also reset specified settings to the factory default value or delete all files/folders in the User drive. Call up the operation display: [MENU] → Cursor buttons [▲][▼][◀][▶] System, [ENTER] → TAB [◀][▶] Reset. For details, refer to the Reference Manual on the website, Chapter 10.

1 Piano Room

– Enjoying the Piano Performance –

The Piano Room function is for those who want to simply, conveniently, and fully enjoy playing the instrument as a piano. No matter what settings you've made from the panel, you can instantly call up the optimum settings for piano performance with a single button press. You can also change the piano settings as you like.

Playing a Piano Performance in the Piano Room

1 Press the [PIANO ROOM] button to call up the Piano Room display.

This calls up the relevant panel settings for piano performance. All buttons on the control panel (excepting the [PIANO ROOM], [EXIT] and [1▲▼] – [8▲▼] buttons) are disabled.

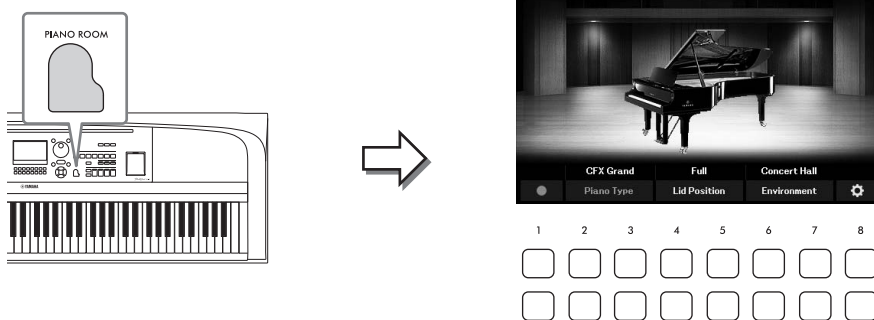

2 Play the keyboard.

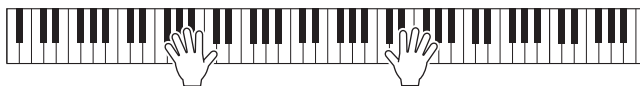

Change the piano settings according to the type of music you want to play or sound you want to create.

Piano Type	Use the [2▲▼]/[3▲▼] buttons to select the desired piano type.
Lid Position	Use the [4▲▼]/[5▲▼] buttons to determine how much the Lid is opened. This can be set only when one of the grand piano types is selected.
Environment (Reverb Type)	Use the [6▲▼]/[7▲▼] buttons to select the desired environment, which automatically calls up the appropriate Reverb type.

3 Press the [PIANO ROOM] button or [EXIT] button to exit the Piano Room display.

All panel settings are restored to those which were set before the Piano Room display was called up.

Making the Detailed Settings in the Piano Room

You can change the settings of the Piano Room, such as touch sensitivity, as you like.

- 1 In the Piano Room display, use the [8▲▼] buttons to call up the setting display, and then change the settings by using the [1▲▼] – [8▲▼] buttons.

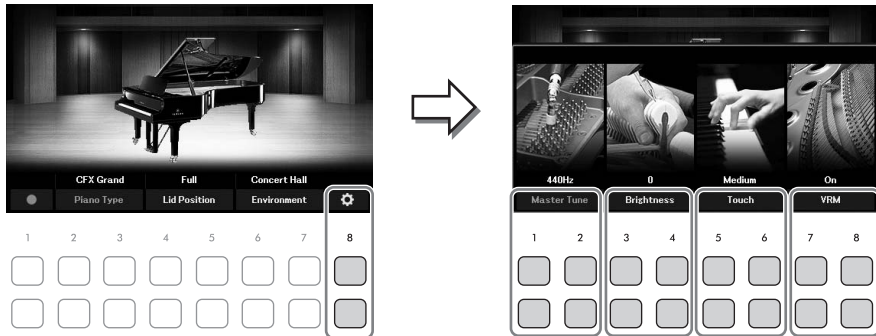

[1▲▼]/ [2▲▼]	Master Tune	Determines the pitch of this instrument in 1Hz steps.
[3▲▼]/ [4▲▼]	Brightness	Determines the brightness of the sound. Higher values result in a brighter sound.
[5▲▼]/ [6▲▼]	Touch	Determines how the sound responds to your playing strength. <ul style="list-style-type: none"> • Hard2: Requires strong playing to produce high volume. Best for players with a heavy touch. • Hard1: Requires moderately strong playing for high volume. • Medium: Standard Touch Response. • Soft1: Produces high volume with moderate playing strength. • Soft2: Produces relatively high volume even with light playing strength. Best for players with a light touch.
[7▲▼]/ [8▲▼]	VRM	Turns the VRM effect on/off. For details on the VRM effect, refer to page 41.

These settings will be maintained even if you exit from this display or turn off the power. Pressing the [PIANO ROOM] button next time will call up the Piano settings which were made the previous time.

- 2 Press the [EXIT] button to exit from the setting display.

Recording your Performance in the Piano Room

- 1 In the Piano Room display, press one of the [1▲▼] (●) buttons to put recording in standby.

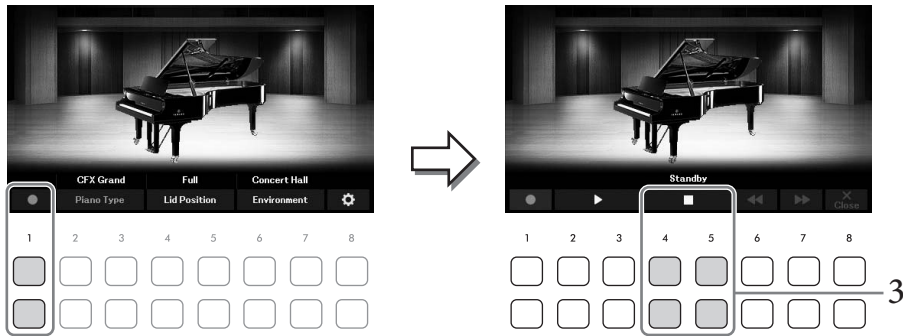

- 2 Play the keyboard to start recording.

You can also start recording by using the [2▲▼]/[3▲▼] (▶) buttons. While recording, “Recording” flashes.

- 3 After you finish your performance, press one of the [4▲▼]/[5▲▼] (■) buttons to stop recording.

- 4 After a message appears prompting you to save, press one of the [7▲▼] (Yes) buttons to save the file.

NOTICE

The recorded data will be lost if you turn the power off without executing the Save operation.

- 5 To hear the recorded performance, press one of the [2▲▼]/[3▲▼] (▶) buttons.

To stop playback, use the [4▲▼]/[5▲▼] (■) buttons. The [6▲▼] (◀◀) buttons are used to rewind, and the [7▲▼] (▶▶) buttons are used to fast forward playback position.

Only the last recorded performance can be played back. Once you press one of the [8▲▼] (Close) buttons, the performance data cannot be played back on the Piano Room display. To play back the performance recorded in the Piano Room, find the data in the **PianoRoom** folder on the **User** tab of the Song selection display (page 61) and play it back as a Song.

2 Voices

– Playing the keyboard with various sounds –

The instrument features a wide variety of exceptionally realistic instrumental Voices, including piano, guitar, strings, brass, wind instruments and more.

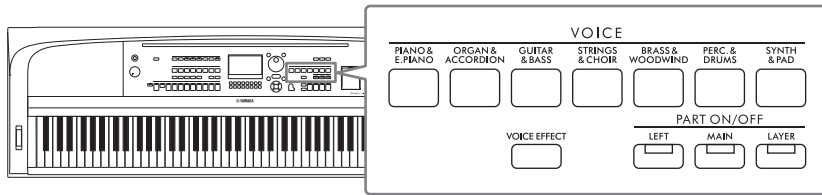

Playing Preset Voices

The Voices can be played via three keyboard parts: Main, Layer and Left. These playing modes allow you to play just one single Voice (Main), play two different Voices in layer (Main and Layer), or play different Voices in the right- and left-hand areas of the keyboard (Main/Layer and Left). By combining these three parts, you can create luscious instrument textures and convenient performance combinations.

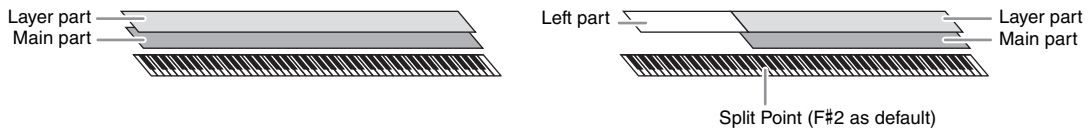

When the Left part is turned off, the entire keyboard is used for the Main and Layer parts. When the Left part is turned on, the F#2 and lower keys are used for the Left part while the upper keys (excluding F#2) are used for the Main and Layer parts. The key which divides the keyboard into the left-hand and right-hand areas is referred to as “Split Point.”

NOTE

The Split Point can be changed (page 58).

- 1 Press one of the PART ON/OFF buttons to turn on the desired keyboard part.

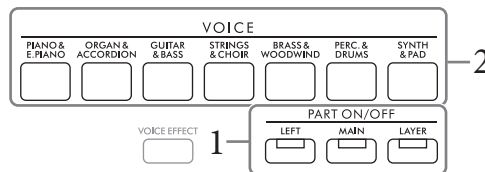

- 2 Press one of the VOICE category selection buttons to select a Voice category and call up the Voice Selection display for the part selected in step 1.

The preset Voices are categorized and contained in appropriate folders. Voice category selection buttons correspond to the categories of the preset Voices.

NOTE

You can select Voices for the Main and Layer parts simply by using the Voice category selection buttons. While holding down one of the VOICE category selection buttons, press another VOICE category selection button. The Voice corresponding to the first pressed button is assigned to the Main part while the Voice of the second pressed button is assigned to the Layer part.

3 Select the desired Voice by using the Cursor buttons [▲][▼][◀][▶].



You can call up the other pages by pressing the buttons ([1▲] – [7▲]) that correspond to the page numbers (P1, P2 ...), or by pressing the same VOICE category selection button repeatedly. Pressing the [8▲] button calls up other Voice categories (folders), including the categories which do not have any VOICE category selection buttons.

NOTE

The Voice characteristics are indicated above the Preset Voice name. For details, see page 40.

To listen to the demo phrases for each Voice

Press the [7▼] (*Demo*) button to start the Demo for the selected Voice. To stop the demo, press the [7▼] button again.

NOTE

If the button is not shown, press the [8▼] (*Close*) button to call it up.

4 If necessary, repeat steps 1 – 3 to select the Voice for the other part.

5 Make sure that the desired keyboard part is turned on.

You can turn each keyboard part on or off by pressing the corresponding PART ON/OFF button. The Voice selected for each keyboard part can be confirmed on the Main display (page 23).

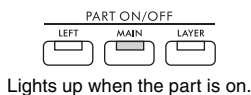

6 Play the keyboard.



Voice Characteristics

There are various Voice types, and some types as described below require special performance considerations. These particular types have an indication above (or in the icon at left of) the Voice name on the Voice Selection display or the Main display. For explanations of the other types, refer to the Reference Manual on the website.



- **VRM Voices (page 41)**

These recreate the characteristic string resonance of a real acoustic piano.

- **Super Articulation (S.Art!) Voices (page 42)**

The word “articulation” in music usually refers to the transition or continuity between notes. This is often reflected in specific performance techniques, such as staccato, legato and slur.

- **Drums/SFX Voices**

Lets you play various drums and percussion instruments or SFX (sound effects) sounds which are assigned to each key. For details on the Key assignments, refer to the **Drum/Key Assignment List** in the Data List on the website. On some Drum and SFX Voices, you can use the Drum Kit Tutor function to see the Key assignment on the display as described below.

Displaying the Instruments Assigned to the Keyboard (Drum Kit Tutor)

For Drum Kit Voices in which the **Drum Kit Tutor** button is shown at the bottom of the Voice Selection display, you can confirm the key assignments in the **Drum Kit Tutor** display.

NOTE

If the File Management menu (page 26) is shown, press the [8▼] (Close) button to see if the **Drum Kit Tutor** button exists or not.

- 1 Select the compatible Drum Kit Voice in the Voice Selection display.
- 2 Press the [4▼] (**Drum Kit Tutor**) button to call up the **Drum Kit Tutor** display.

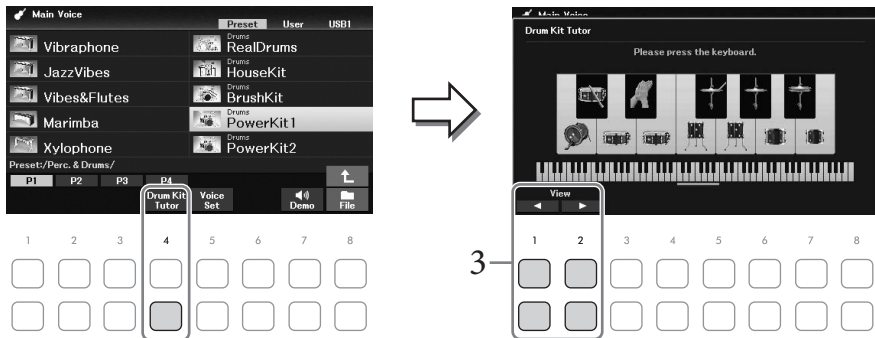

- 3 Press the desired key to check the key assignment.

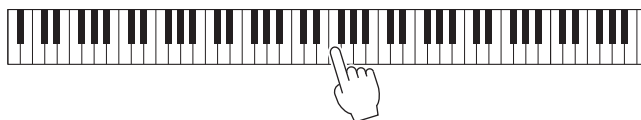

The illustration and the name of the instrument assigned to the key appear on the **Drum Kit Tutor** display. To shift the illustration and instrument names by octaves, use the [1▲▼] and [2▲▼] buttons (or press the desired key outside the displayed range).

Calling up the Appropriate Settings for Piano Performance (Piano Reset)

You can easily reset to appropriate settings for playing the instrument as a piano, no matter what settings you've made from the panel. This function called "Piano Reset" allows you to play the *CFX Grand* Voice across the entire keyboard.

NOTE

This function cannot be used while the Piano Room display (page 35) is shown.

- 1 Press and hold down the [PIANO ROOM] button for two seconds or longer.

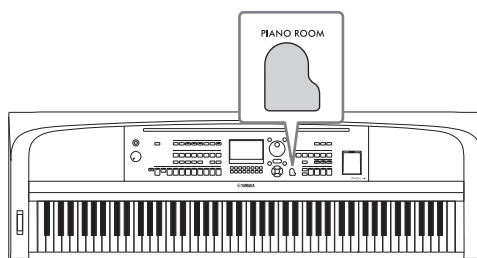

A message appears in the display.

- 2 Press one of the [7▲▼] (*Reset*) buttons to call up the appropriate settings for playing as a piano.

Playing Realistic Resonance-enhanced Piano Sounds (VRM Voices)

Simply by selecting a VRM Voice, you can enjoy the VRM effect (see below). VRM Voices can be selected via the VOICE category [PIANO & E. PIANO] button. A VRM Voice is indicated by "VRM" above the Voice name on the Voice Selection display or the Main display.

The default setting of the VRM effect is on. You can turn it on or off, and adjust the depth via [MENU] → Cursor buttons [▲][▼][◀][▶] *Voice Setting*, [ENTER] → TAB [◀] *Piano* → Cursor button [▲] **1 VRM**. For details, refer to the Reference Manual on the website.

VRM (Virtual Resonance Modeling)

On a actual acoustic piano, if you press the damper pedal and play a key, not only does the string of the pressed key vibrate, it also causes other strings and the soundboard to vibrate, with each influencing the rest, creating a rich and brilliant resonance that sustains and expands. The VRM (Virtual Resonance Modeling) technology featured in this instrument reproduces the complicated interaction between both string and soundboard resonance, and make the sound more like that of a real acoustic piano. Since resonance instantaneously occurs depending on the action of the keys and pedal, you can expressively vary the sound by changing the timing of your pressing the keys, and the timing and depth of your pressing the pedal.

Playing Super Articulation Voices

The Super Articulation Voices enable you to create subtle, very realistic musical expressions, simply by how you play. “S.Art!” is shown above the Voice name of Super Articulation Voices on the Voice Selection display or the Main display.

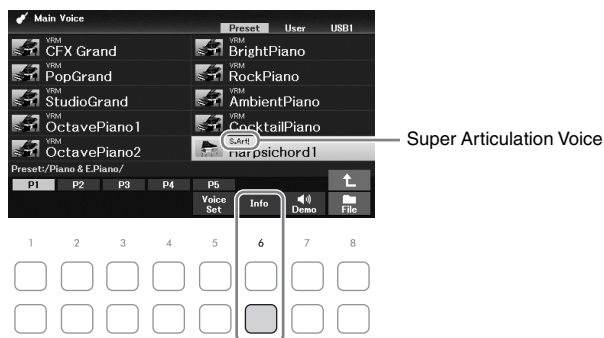

For performance instructions, you can call up the Information window of the selected Super Articulation Voice by pressing the [6▼] (*Info*) button on the Voice Selection display.

NOTE

If the button is not shown, press the [8▼] (*Close*) button to call it up.

Example: Saxophone Voice

If you play a C note and then an adjacent D in a very legato way, you will hear the note change seamlessly, as though a saxophone player played it in a single breath.

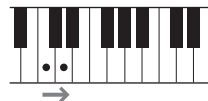

Example: Guitar Voice

If you play a C note and then the E just above in a very legato but firm way, the pitch slides up from C to E.

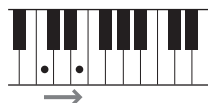

Adding Articulation Effects by Using the Pedal Unit (sold separately)

When you select a Super Articulation Voice for the Main part, the function of the center or/and left pedals are switched to control articulation effects. Pressing a pedal triggers different playing effects, separate from your keyboard playing. For example, pressing a pedal for a saxophone Voice can produce breath noises or key noises, while doing the same for a guitar Voice can produce fret noises or body-tapping sounds. You can effectively intersperse these into the notes as you play.

NOTE

If you want to lock the pedal function regardless of the Voice, turn off the *Switch with Main Voice* parameter. The operation display can be called up via [MENU] → Cursor buttons [▲][▼][◀][▶] *Controller*, [ENTER] → TAB [▶] *Setting* → Cursor button [▼] 3 *Switch with Main Voice*.

NOTE

- Super Articulation Voices are only compatible with other models which have those types of Voices installed. Any Song or Style data you've created on the instrument using this Voice will not sound properly when played back on other instruments.
- Super Articulation Voices sound differently depending on the keyboard range, velocity, touch, etc. Hence, if you turn on a Keyboard Harmony effect, change the transpose setting or change the Voice Set parameters, unexpected or undesired sounds may result.

Setting the Touch Response of the Keyboard

You can adjust the touch sensitivity of the instrument (how the sound responds to the way you play the keys). This setting does not change the weight of the keyboard.

1 Call up the operation display.

[MENU] → Cursor buttons [▲][▼][◀][▶] **Controller**, [ENTER] → TAB [▶] **Setting** → Cursor button [▲] **1 Touch Response**.

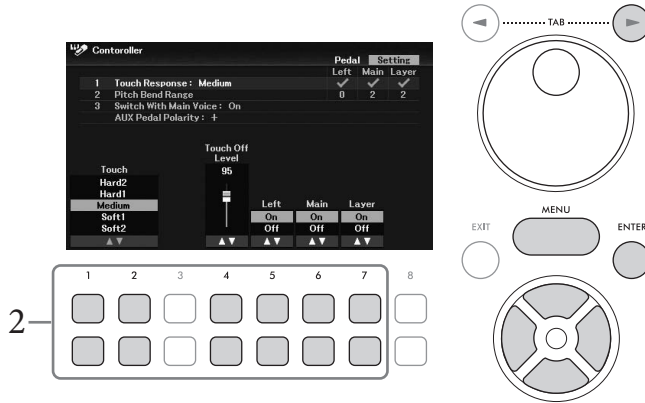

2 Use the [1▲▼] - [7▲▼] buttons to set the Touch Response.

[1▲▼]/ [2▲▼]	Touch	<ul style="list-style-type: none"> • Hard2: Requires strong playing to produce high volume. Best for players with a heavy touch. • Hard1: Requires moderately strong playing for high volume. • Medium: Standard Touch Response. • Soft1: Produces high volume with moderate playing strength. • Soft2: Produces relatively high volume even with light playing strength. Best for players with a light touch.
[4▲▼]	Touch Off Level	Determines the velocity level when Touch Response for any parts (the parameter below) is set to Off . In other words, the volume is fixed to this level regardless of your playing strength.
[5▲▼] - [7▲▼]	Main, Layer, Left	Turns Touch Response on or off for each keyboard part.

Using the Metronome

The [METRONOME] button lets you start or stop the metronome. The metronome provides a click sound, giving you an accurate tempo guide when you practice, or letting you hear and check how a specific tempo sounds.

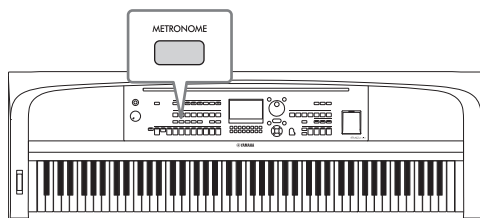

Metronome tempo can be adjusted by the same procedure as with Style tempo (page 52).

NOTE

You can change the time signature, volume and sound of the metronome on the display called up via [MENU] → Cursor buttons [▲][▼][◀][▶] *Metronome Setting*, [ENTER] → Cursor button [▲] *1 Metronome*. For details, refer to the Reference Manual on the website.

Changing the Pitch of the Keyboard

Adjusting the Pitch in Semitones (Transpose)

The TRANSPOSE [-]/[+] buttons transpose the overall pitch of the instrument (the keyboard sound, Style playback, Song playback, and so on) in semitone steps (from -12 and 12). To instantly reset the value to 0, press the [+] and [-] buttons simultaneously.

NOTE

The Transpose functions do not affect the Drum Kit or SFX Kit Voices.

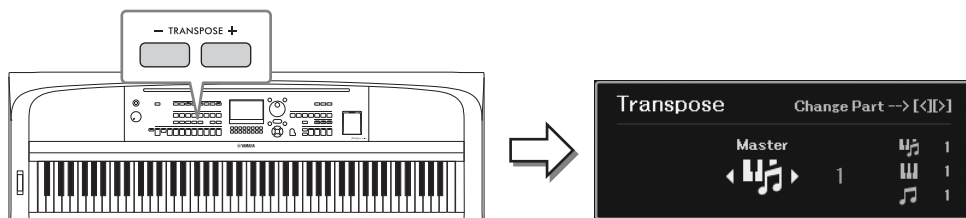

You can independently select the part to be transposed as desired. Press the Cursor button [◀]/[▶] several times until the desired part appears, and then use the TRANSPOSE [-]/[+] buttons to transpose it.

Master	Transposes the pitch of the entire sound with the exception of the Audio file playback, the input sound from the [MIC INPUT] jack and the Audio Input Sound (page 95) from the external device.
Keyboard	Transposes the keyboard pitch including the chord root for triggering Style playback.
Song	Transposes the pitch of the Song.

Fine Tuning the Pitch

By default, the pitch of the entire instrument is set to 440.0 Hz according to equal temperament. This basic tuning can be changed in the display called up via [MENU] → Cursor buttons [▲][▼][◀][▶] **Master Tune/Scale Tune**, [ENTER]. For details, refer to the Reference Manual on the website.

NOTE

You can also adjust the pitch for each keyboard part (Main/Layer/Left) in the display called up via [MENU] → Cursor buttons [▲][▼][◀][▶] **Voice Setting**, [ENTER] → TAB [◀][▶] **Tune**.

Using the Pitch Bend Wheel

Use the [PITCH BEND] wheel to bend the pitch up (roll the wheel away from you) or down (roll the wheel toward you) while playing the keyboard. The Pitch Bend is applied to all the keyboard parts (Main, Layer and Left). The [PITCH BEND] wheel is self-centering and will automatically return to normal pitch when released.

NOTE

The effects produced by using the [PITCH BEND] wheel may not be applied to the Left part during Style playback, depending on the Style setting.

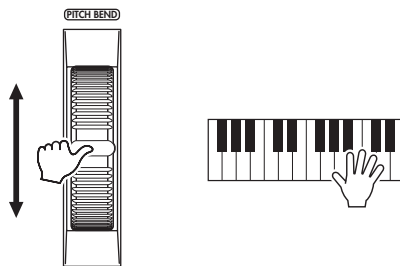

The maximum pitch bend range can be changed in the display called up via [MENU] → Cursor buttons [▲][▼][◀][▶] **Controller**, [ENTER] → TAB [▶] **Setting** → Cursor buttons [▲][▼] **2 Pitch Bend Range**.

Applying Voice Effects

The instrument features a sophisticated multi-processor effect system which can add extraordinary depth and expression to your sound.

- 1 Press the [VOICE EFFECT] button to call up the *Voice Effect* display.

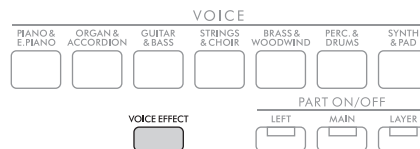

- 2 Use the Cursor buttons [▲][▼] to select the page, and then use the [1▲▼] – [7▲▼] buttons to apply effects to the Voices.

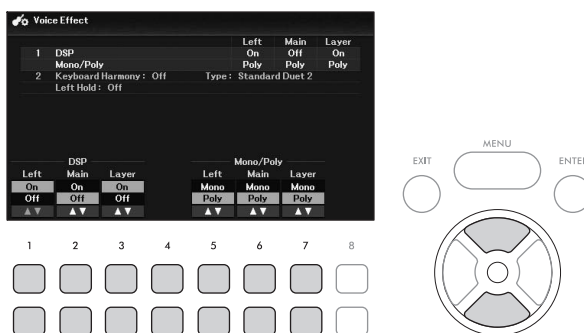

1	[1▲▼] – [3▲▼]	DSP	Turns the DSP (Digital Signal Processor) effect on or off for each keyboard part. With the digital effects built into the instrument, you can add ambience and depth to your music in a variety of ways—such as adding reverb that makes you sound like you are playing in a concert hall. NOTE The effect type can be changed. On the Voice Selection display, select [5▼] (Voice Set) → TAB [◀][▶] Effect/EQ → Cursor buttons [▲][▼] 2 DSP Type. For details, refer to the Reference Manual on the website.
	[5▲▼] – [7▲▼]	Mono/Poly	Determines whether the Voice of the selected keyboard part is played monophonically or polyphonically. When Mono is selected, the part's Voice is played monophonically (only one note at the time) with last note priority, letting you play single, lead sounds such as brass instruments more realistically. Depending on the selected Voice, Portamento may be produced when notes are played with legato. NOTE Portamento is a function that creates a smooth transition in pitch from the first note played on the keyboard to the next.
2	[2▲▼] / [3▲▼]	Keyboard Harmony	When the Keyboard Harmony function is set to On by using the [2▲▼]/[3▲▼] buttons, the Harmony type selected on the display called up via the [4▲▼] buttons can be applied to the right-hand section of the keyboard. For details, refer to the Reference Manual on the website.
	[4▲▼]	Type	
	[6▲▼] / [7▲▼]	Left Hold	When this is set to On , the Voice for the Left part is held even when the keys are released. Non-decaying Voices such as strings are held continuously, while decaying Voices (such as piano) decay more slowly (as if the sustain pedal has been pressed). When the Left Hold function is set to On , an “H” indication appears at the right corner of the Left part on the Main display. 

Advanced Features

Refer to the Reference Manual on the website, Chapter 2.



Metronome settings: [MENU] → Cursor buttons [▲][▼][◀][▶] *Metronome Setting*, [ENTER]

Adjusting the Reverb/Chorus depth and other settings for piano Voices: [MENU] → Cursor buttons [▲][▼][◀][▶] *Voice Setting*, [ENTER] → TAB [◀] *Piano*

Applying Keyboard Harmony: [MENU] → Cursor buttons [▲][▼][◀][▶] *Keyboard Harmony*, [ENTER] or [VOICE EFFECT] → Cursor button [▼] 2 *Keyboard Harmony* → [4▲▼] (*Type*)

Pitch-related settings

• Fine-tuning the pitch of the entire instrument: [MENU] → Cursor buttons [▲][▼][◀][▶] *Master Tune/Scale Tune*, [ENTER] → TAB [◀] *Master Tune*

• Scale Tuning: [MENU] → Cursor buttons [▲][▼][◀][▶] *Master Tune/Scale Tune*, [ENTER] → TAB [▶] *Scale Tune*

• Pitch settings for each keyboard part: [MENU] → Cursor buttons [▲][▼][◀][▶] *Voice Setting*, [ENTER] → TAB [◀][▶] *Tune*

Editing Voices (Voice Set): Voice Selection display → [5▼] (*Voice Set*)

Disabling automatic selection of Voice Sets (effects, etc.): [MENU] → Cursor buttons [▲][▼][◀][▶] *Voice Setting*, [ENTER] → TAB [▶] *Voice Set Filter*

3 Styles

– Playing Rhythm and Accompaniment –

The instrument features various accompaniment and rhythmic backing patterns (called “Styles”) in a variety of different musical genres including pop, jazz, and many others. The Style features Auto Accompaniment which detects the “chords” automatically, and lets you produce automatic accompaniment playback simply by playing the keyboard. This lets you automatically recreate the sound of a full band or orchestra — even if you’re playing by yourself.

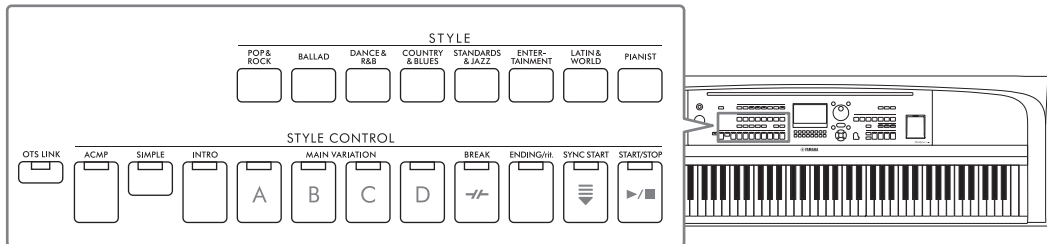

Playing a Style with the Auto Accompaniment

- 1 Press one of the **STYLE** category selection buttons to call up the Style Selection display.



- 2 Select the desired Style by using the Cursor buttons [▲][▼][◀][▶].

You can call up the other pages by pressing the buttons ([1▲] – [7▲]) that correspond to the page numbers (P1, P2 ...) or by pressing the same STYLE category selection button several times.



- 3 Make sure that the **STYLE CONTROL** [ACMP] button is on (the lamp is lit).



A Style generally consists of eight parts (channels): rhythm, bass and various accompaniment parts. By turning on the [ACMP] button, all your desired parts can be played back, while turning it off enables play for only the rhythm parts.

4 Press the STYLE CONTROL [SYNC START] button to enable synchronized start (page 50).

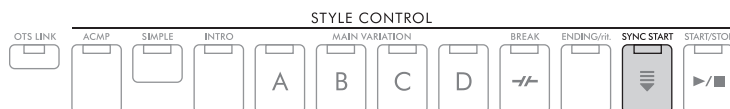

5 As soon as you play the keyboard, the selected Style starts playback.



NOTE

- If you want to make the accompaniment simpler, turn the [SIMPLE] button on. Doing so enables only the rhythm and bass, and turns other parts off (page 53).
- You can add variations and change the feeling of a Style by selectively turning channels on/off or by changing the Voices (page 53).

By default, the Chord Fingering type (page 56) is **AI Full Keyboard**, and by just playing anywhere on the keyboard using both hands as you like, the instrument automatically detects the chords and plays the accompaniment automatically.

On the other hand, when the Chord Fingering type is set to something other than **AI Full Keyboard** or **Full Keyboard** (and the [ACMP] button is on), a specifically assigned left-hand section of the keyboard is used as the Chord section, and chords played in this section are automatically detected and used as a basis for fully automatic accompaniment with the selected Style.

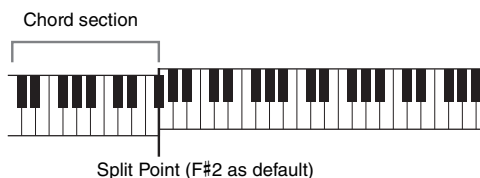

NOTE

- The Split Point can be changed as desired (page 58).
- By default, the chord section (Chord Detection Area) is set to the left-hand section, but you can change it to the right-hand section (page 57) if desired.

6 Press the STYLE CONTROL [START/STOP] button to stop Style playback.

You can also stop playback by pressing the [ENDING/rit.] button (page 50).

Style Characteristics

The Style types and their defining characteristics are indicated above the Style name on the Style Selection display or the Main display. Details are explained on page 51 for **Adaptive** and page 54 for **Unison**. For other types, refer to the Reference Manual on the website.



Style File Compatibility

This instrument uses the SFF GE file format (page 108) and can play back existing SFF files; however, they will be saved in the SFF GE format when the file is saved (or loaded) in this instrument. Please keep in mind that the saved file can only be played back on instruments that are compatible with the SFF GE format.

Operating Style Playback

To Start/Stop Playing

■ [START/STOP] button

Starts playback of the rhythm part of the current Style. To stop playback, press this button again.



Playing back both rhythm and auto accompaniment ([ACMP] button)

If you turn on the [ACMP] button, both the rhythm part and auto accompaniment can be played back according to the detected chords during Style playback.



NOTE

- The rhythm does not sound for some Styles. When you want to use any of these Styles, always make sure that [ACMP] button is turned on.
- By default, the [ACMP] button is turned on when you turn the power on. You can set whether the [ACMP] button is on or off when the power is turned on via [MENU] → Cursor buttons [▲][▼][◀][▶] *Style Setting*, [ENTER] → TAB [◀][▶] *Setting2* → Cursor button [▲] 1 *ACMP On/Off Default*.

■ [SYNC START] button

This puts the Style playback in standby. The Style starts playing back when you play the keyboard. During Style playback, pressing this button stops the Style and puts playback in standby.



NOTE

When the Chord Fingering type (page 56) is set to something other than *AI Full Keyboard* or *Full Keyboard*, the Style starts playing back when you play a chord with your left hand (when the [ACMP] button is on) or you press any note on the keyboard (when the [ACMP] button is off).

■ [INTRO] button

This adds an introduction before starting Style playback. After pressing the [INTRO] button, start playback of the Style. When the Intro finishes playing, Style playback automatically shifts to the Main section.



■ [ENDING/rit.] button

This adds an ending before stopping Style playback. When you press the [ENDING/rit.] button while a Style is playing back, the Style will automatically stop after the ending is played. You can have the ending gradually slow down (*ritardando*) by pressing the [ENDING/rit.] button once again, while the ending is playing.



NOTE

The Intro and Ending sections feature three types (sets) for each Style. If you want to use a different set of Intro and Ending sections, you can select it on the display called up via [MENU] → Cursor buttons [▲][▼][◀][▶] *Style Setting*, [ENTER] → TAB [◀][▶] *Setting2* → Cursor button [▲] 1 *Intro/Ending Set*. For details, refer to the Reference Manual on the website.

Changing Variation (Sections) During Style Playback

Each Style features four different Main sections, four Fill-in sections and a Break section. By using these sections effectively, you can easily make your performance sound more dynamic and professional. The section can be freely changed while the Style is playing back.

■ MAIN VARIATION [A] – [D] buttons

Press one of the MAIN VARIATION [A] – [D] buttons to select the desired Main section (the button lights in orange). Each is an accompaniment pattern of a few measures and it plays indefinitely. Pressing the selected MAIN VARIATION button again plays an appropriate fill-in pattern to spice up the rhythm and break the repetition. After the fill-in finishes playing, it leads smoothly into the Main section.

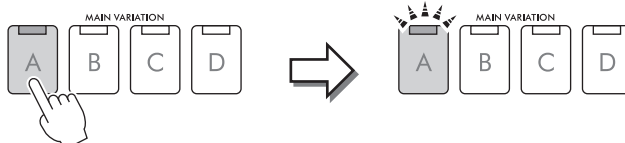

Press the selected Main section (lit in orange) again.

The fill-in of the selected Main section plays (flashes in orange).

Automatically Shifting the Main Variations (Adaptive Style)

For Styles which have an “*Adaptive*” indication above the Style name on the Style Selection display, the Adaptive Style function can be used. When the Adaptive Style function is turned on, the Main variations changes automatically depending on how dynamically you play the keyboard (such as playing strength and numbers of notes you play) without needing to press the MAIN VARIATION buttons. In between the Main A, B, C and D sections, three variations similar to the adjacent section(s) are provided and there are 13 types of variations (as shown below). From these variations, the most appropriate variation for your current performance is played back. For example, as you play the keyboard more dynamically, you can bring the dynamics down by playing more sparsely. Naturally, the opposite is also true; the Auto Accompaniment of the Style increases in dynamic intensity. To use this function, turn the function on via [MENU] → Cursor buttons [▲][▼][◀][▶] **Style Setting**, [ENTER] → TAB [▶] **Adaptive** → [1▲▼] (**Adaptive Style**), and then play a Style with Auto Accompaniment (page 48).

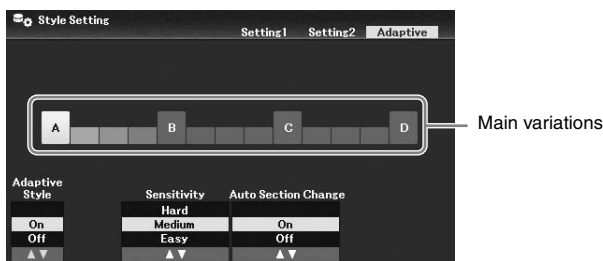

If necessary, you can adjust the sensitivity (how the variations respond to your performance) by using the [3▲▼]/[4▲▼] (**Sensitivity**) buttons.

- **Hard:** Requires strong playing for making changes. Suitable for energetic music such as rock music.
- **Medium:** Medium sensitivity.
- **Easy:** Changes easily even with light playing strength. Suitable for gentle music such as ballad music.

By default, the Main variation shifts cross over the sections A, B, C and D, however, you can limit the changes within the variations so that they’re close to the current Main variation. For example, when Main B is selected, the variation is changed within the 7 types including B, and never changes to A, C or D. To do this, use the [5▲▼]/[6▲▼] (**Auto Section Change**) buttons to set the function to **Off**. When you want to make large variation changes, use the MAIN VARIATION buttons.

Automatically Changing One Touch Settings with the Main Sections (OTS Link)



One Touch Setting (OTS) is a convenient feature that automatically calls up the most appropriate panel settings (Voices or effects, etc.) for the currently selected Style. When the [OTS LINK] button is turned on, pressing a different MAIN VARIATION button (A – D) automatically calls up a One Touch Setting appropriate for the selected Main section.

NOTE

- You can call up the information window to confirm which Voices are prepared for each Main section (A – D) of the current Style by pressing the [6▼] (*Info*) button. If the button is not shown, press the [8▼] (*Close*) button to call it up. Gray color for a Voice name indicates that the corresponding part is currently turned off.
- When using the Adaptive Style function (page 51), the OTS is not called up when the Main sections are changed automatically, even if the [OTS LINK] button is turned on.
- When you change the Voice after the OTS is called up, or when the Main section is changed without pressing any MAIN VARIATION buttons (such as when using the Adaptive Style function), you can recall the previous OTS by turning the [OTS LINK] button off and turning it on again.

Adding a Fill-in when changing the Main section

By default, the Auto Fill-in function is turned on and pressing any of the MAIN VARIATION [A] – [D] buttons as you play automatically plays a fill-in section. This function can be turned on or off via [MENU] → Cursor buttons [▲][▼][◀][▶] *Style Setting*, [ENTER] → TAB [◀] *Setting1* → Cursor button [▲] *1 Auto Fill-in On/Off*.

■ [BREAK] button

This lets you add dynamic breaks in the rhythm of the accompaniment. Press the [BREAK] button during Style playback. When the one-measure Break pattern finishes playing, the Style playback automatically shifts to the Main section.



About the lamp status of the section buttons (INTRO/MAIN VARIATION/BREAK/ENDING)

- **Orange:** The section is currently selected.
- **Orange (flashing):** The section will be played next, following the currently selected section.
 - * The MAIN VARIATION [A] – [D] button lamps also flash in orange.
- **Green:** The section contains data but is not currently selected.
- **Off:** The section contains no data and cannot be played.

Adjusting the Volume Balance

You can adjust the volume balance among the keyboard parts (Main, Layer, Left), the Style, the Song, the USB Audio Player, the microphone sound, and the Audio Input Sound from the external device (page 95). These can be adjusted in the *Volume/Pan* tab on the *Mixer* display. For details, refer to page 88.

Adjusting the Tempo

The [TEMPO/TAP] button lets you change the playback tempo of Metronome, Style and Song. Press the [TEMPO/TAP] button to call up the Tempo pop-up display, and then use the [4▲▼]/[5▲▼] buttons or the Data dial to adjust the tempo over a range of 5 – 500 beats per minute. To reset the tempo to the default value, press the [4▲] and [4▼] (or [5▲] and [5▼]) buttons simultaneously.

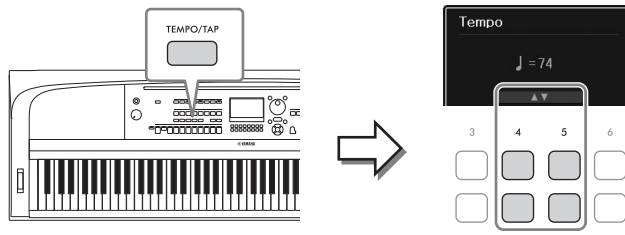

During playback of a Style or Song, you can change the tempo by tapping the [TEMPO/TAP] button twice at the desired tempo. When Style and Song are stopped, tapping the [TEMPO/TAP] button (four times for a 4/4 time signature) starts playback of the rhythm part of the Style at the tempo you tapped.

Playing Back Only the Rhythm and Bass Parts of the Style

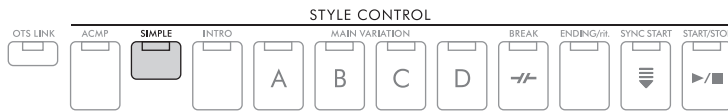

A Style generally consists of eight parts (channels): rhythm, bass and various accompaniment parts (see below). When the [ACMP] button is on, all these parts are usually played back. However, if you turn the [SIMPLE] button on, you can easily strip the arrangement down to only the rhythm and bass parts, turning all other parts off—making it ideal especially for piano performance.

Turning Each Part (Channel) of the Style On/Off

Each Style contains the channels listed below. You can add variations and change the feeling of a Style by selectively turning channels on/off as the Style plays.

Style channels

- **Rhy1, 2** (Rhythm 1, 2): These are the basic parts of the Style, containing the drum and percussion rhythm patterns.
- **Bass**: The bass part uses various appropriate instrument sounds to match the Style.
- **Chd1, 2** (Chord 1, 2): These are rhythmic chord backing parts, commonly used with piano or guitar Voices.
- **Pad**: This part is used for sustained instruments such as strings, organ, choir, etc.
- **Phr1, 2** (Phrase 1, 2): These parts are used for punchy brass stabs, arpeggiated chords, and other extras that make the accompaniment more interesting.

- 1 Press the [CHANNEL ON/OFF] button several times to call up the *Channel On/Off* (Style) display which contains the desired channel.

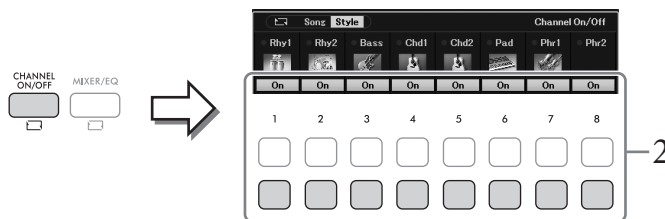

2 Use the [1▼] – [8▼] buttons to turn the channels on or off.

To play only one channel by itself, hold down the appropriate button for the channel to set the channel to *Solo*. To cancel *Solo*, simply press the appropriate channel button again.

To change the Voice for each channel

Press one of the [1▲] – [8▲] buttons of the corresponding to the desired channel to call up the Voice Selection display (page 39), and then select the desired Voice.

NOTE

You can save the settings made here to Registration Memory (page 81).

3 Press the [EXIT] button to close the *Channel On/Off (Style)* display.

Playing in Unison or Adding Accents to Style Playback (Unison & Accent)

The powerful Unison & Accent function gives you expressive and nuanced control over Style playback, letting you create various musical variations in the accompaniment. With the Unison function turned on, you can play a melody and have it reproduced in unison (i.e., the same melody is played by multiple instruments) or tutti (i.e., all parts are played at the same time)—expressively enhancing your performance and letting you create dynamic phrases. With the Accent function turned on, accents are automatically generated by adding notes to Style playback according to your playing strength (or accents you play). This allows you to temporary change or interrupt the regular rhythm patterns. For the Styles compatible with the Unison & Accent function, “*Unison*” is indicated above the Style name on the Style Selection display.

Using the Unison Function

- 1 Select a compatible Style which has a “*Unison*” indication above the Style name on the Style Selection display.
- 2 Call up the operation display.
[MENU] → Cursor buttons [▲][▼][◀][▶] *Style Setting*, [ENTER] → TAB [◀] *Setting1* → Cursor button [▲] *1 Unison/Accent Threshold*

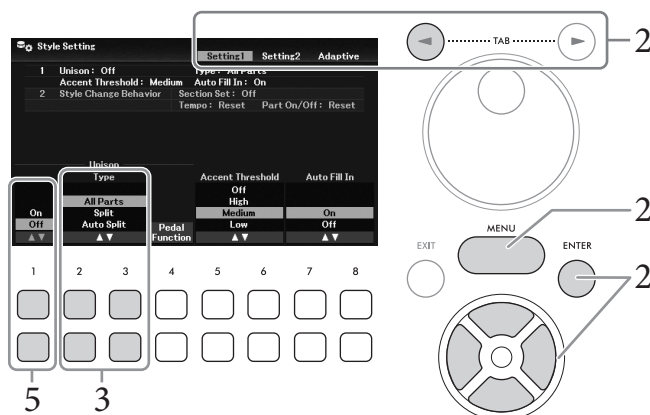

3 Use the [2▲▼]/[3▲▼] (*Unison Type*) buttons to select the type of the Unison function.

- **All Parts:** Suitable for a one-hand performance. In this type, all the accompaniment parts are played in unison with your performance. This can be used relatively easily even by a beginner.
- **Split:** Suitable for a both-hands performance. In this type, the keyboard is divided by the Left Split Point (page 58), and the accompaniment parts suitable for each hand are played in unison with your performance independently. For example, low-pitched sound musical instruments (such as bass guitar, baritone saxophone, and contrabass) are played in unison with the left hand, and solo musical instruments (such as flute) are played with the right. It is useful for playing with different Voices between your left and right hands.
- **Auto Split:** Suitable for a both-hands performance. In this type, the right- and left-hand sections of your performance are detected, and the accompaniment parts to be played in unison are automatically assigned to each hand. This is recommended when playing tutti with Voices having a wide range, such as piano or strings. This allows you to play freely without the limitations of a specific Split Point.

4 Play the keyboard along with Style playback.



5 At the desired timing (the point you want to play in Unison), turn on the Unison function by using the [1▲▼] (*Unison On/Off*) buttons.

You can conveniently turn on/off the Unison function also by using the connected pedal. To do this, use the [4▲▼] (*Pedal Function*) buttons to call up the *Pedal Function* display, and then assign “*Unison*” to the desired pedal. This display is the same as the *Pedal* tab of the *Controller* display. For instructions on this display, refer to the Reference Manual on the website, Chapter 9.

6 When you finish playing in unison, turn off the Unison function by using the [1▲▼] (*Unison On/Off*) buttons, and then play the keyboard to return to normal playback.

Using the Accent Function

1 Select a compatible Style and call up the operation display (steps 1 – 2 on page 54).

2 If necessary, select the level at which the accents are added depending on your playing strength by using the [5▲▼]/[6▲▼] (*Accent Threshold*) buttons.

- **High:** Requires strong playing (higher velocity) to have the Style generate accents.
- **Medium:** Standard setting.
- **Low:** Allows you to have the Style generate accents even with relatively light playing strength (lower velocity).

If you want to turn off the Accent function, select *Off* here.

3 Play the keyboard along with Style playback.

Changing the Chord Fingering Type





The Chord Fingering type determines how the chords are detected when you play along with Style playback with the [ACMP] button turned on.

1 Call up the operation display.

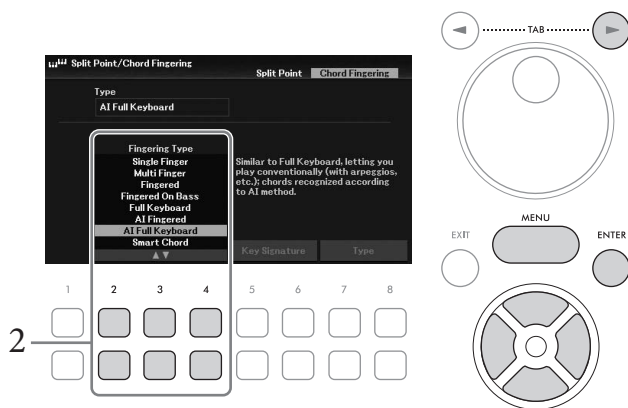
[MENU] → Cursor buttons [▲][▼][◀][▶] *Split Point/Chord Fingering*, [ENTER] → TAB
[▶] *Chord Fingering*

2 Use the [2▲▼] - [4▲▼] buttons to select a Chord Fingering type.



<p>Single Finger</p>	<p>Allows you to easily play chords in the accompaniment range of the keyboard using only one, two or three fingers. This type is available only for Style playback.</p> <p>C  Major chord Press the root key only.</p> <p>Cm  Minor chord Simultaneously press the root key and a black key to its left.</p> <p>C7  Seventh chord Simultaneously press the root key and a white key to its left.</p> <p>Cm7  Minor seventh chord Simultaneously press the root key and both a white and black key to its left.</p>
<p>Multi Finger</p>	<p>Automatically detects <i>Single Finger</i> or <i>Fingered</i> chord fingerings, so you can use either type of fingering without having to switch fingering types.</p>
<p>Fingered</p>	<p>Allows you to finger your own chords on the chord section of the keyboard, while the instrument supplies appropriately orchestrated rhythm, bass, and chord accompaniment in the selected Style.</p> <p><i>Fingered</i> recognizes the various chord types which are listed on the Reference Manual on the website and can be looked up using the Chord Tutor function called up via [MENU] → Cursor buttons [▲][▼][◀][▶] <i>Chord Tutor</i>, [ENTER].</p>
<p>Fingered On Bass</p>	<p>Accepts the same fingerings as <i>Fingered</i>, but the lowest note played in the Chord section of the keyboard is used as the bass note, allowing you to play “on bass” chords. (In <i>Fingered</i>, the root of the chord is always used as the bass note.)</p>

Full Keyboard	Detects chords in the entire key range. Chords are detected in a way similar to Fingered , even if you split the notes between your left and right hands—for example, playing a bass note with your left hand and a chord with your right, or by playing a chord with your left hand and a melody note with your right.
AI Fingered	Basically the same as Fingered , with the exception that less than three notes can be played to indicate the chords (based on the previously played chord, etc.).
AI Full Keyboard	When this advanced fingering type is engaged, the instrument will automatically create appropriate accompaniment while you play just about anything, anywhere on the keyboard using both hands. You don't have to worry about specifying the Style chords. Although the AI Full Keyboard type is designed to work with many songs, some arrangements may not be suitable for use with this feature. This type is similar to Full Keyboard , with the exception that less than three notes can be played to indicate the chords (based on the previously played chord, etc.). 9th, 11th and 13th chords cannot be played. This type is available only for Style playback.
Smart Chord	Allows you to easily control the Style with just a single finger as long as you know the key of the music you are playing, even if you don't know any chord fingering. Appropriate chords suited for the specified music genre will sound whenever you press a single note, as if you were playing the “right” chords. For details, refer to the Reference Manual on the website.

NOTE

When the Chord Detection Area is set to *Upper* (see below), only *Fingered** is available. This type is basically same as *Fingered*, except that “1+5,” “1+8” and Chord Cancel are not available.

Specifying Chords with Your Right Hand for Style Playback (Changing the Chord Detection Area)

By changing the Chord Detection Area from the left-hand section (*Lower*) to the right-hand section (*Upper*), you can play the bass line with your left hand while using your right hand to control Style playback. This can be set on the display called up via [MENU] → Cursor buttons [▲][▼][◀][▶] **Split Point/Chord Fingering**, [ENTER] → TAB [◀] **Split Point**. For details, refer to the Reference Manual on the website.

Changing the Split Points

The key which divides the keyboard into two or three areas is referred to as “Split Point.” There are two types of Split Point: “Left Split Point” and “Style Split Point.” The “Left Split Point” divides the keyboard into the Left part area and Main part area while the “Style Split Point” divides the keyboard into the Chord section for Style playback (page 49) and the Main or Left part area. Though both Split Points are at the same key (F#2) by default, you can also set them individually (as shown).

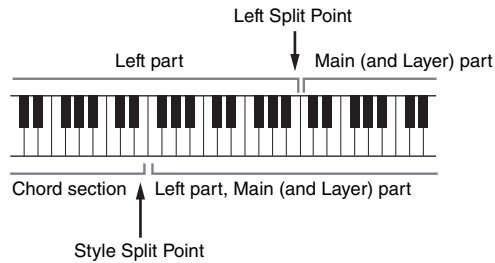

1 Call up the Split Point display.

[MENU] → Cursor buttons [▲][▼][◀][▶] **Split Point/Chord Fingering**, [ENTER] → TAB [◀] **Split Point**

2 Set the Split Point.

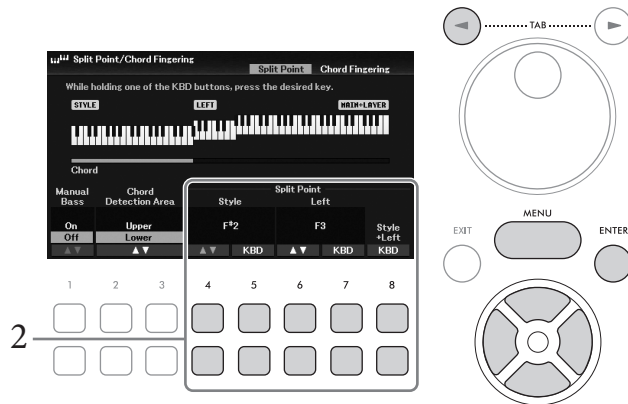

[4▲▼]/ [5▲▼]	Style	Sets the Style Split Point. Use the [4▲▼] buttons or press the desired key on the keyboard while holding one of the [5▲▼] (KBD) buttons to specify the Split Point.
[6▲▼]/ [7▲▼]	Left	Sets the Left Split Point. Use the [6▲▼] buttons or press the desired key on the keyboard while holding one of the [7▲▼] (KBD) buttons to specify the Split Point. NOTE The Left Split Point cannot be set lower than the Style Split Point.
[8▲▼]	Style + Left	Sets Style Split Point and Left Split Point to the same note. Rotate the Data dial or press the desired key on the keyboard while holding one of the [8▲▼] (KBD) buttons to specify the Split Point.

Advanced Features

Refer to the Reference Manual on the website, Chapter 3.



Playing Style with the Smart Chord feature: [MENU] → Cursor buttons [▲][▼][◀][▶] *Split Point/Chord Fingering*, [ENTER] → TAB [▶] *Chord Fingering* → [2▲▼] – [4▲▼] *Smart Chord*

Learning how to play specific chords (Chord Tutor): [MENU] → Cursor buttons [▲][▼][◀][▶] *Chord Tutor*, [ENTER]

Style playback related settings: [MENU] → Cursor buttons [▲][▼][◀][▶] *Style Setting*, [ENTER]

Specifying chords with your right hand while playing bass with your left hand: [MENU] → Cursor buttons [▲][▼][◀][▶] *Split Point/Chord Fingering*, [ENTER] → TAB [◀] *Split Point*

Creating/editing Styles (Style Creator) [MENU] → Cursor buttons [▲][▼][◀][▶] *Style Creator*, [ENTER]

- Realtime Recording: → TAB [◀][▶] *Basic*
- Style Assembly: → TAB [◀][▶] *Assembly*
- Editing the rhythmic feel: → TAB [◀][▶] *Groove*
- Editing data for each channel: → TAB [◀][▶] *Channel*
- Making Style File Format settings: → TAB [◀][▶] *Parameter*
- Editing the rhythm part of a Style (Drum Setup): → TAB [◀][▶] *Basic* → Cursor button [▼] *3 Drum Setup*

4 Songs

– Playing, Practicing and Recording Songs –

For this instrument, “Song” refers to MIDI data which include preset Songs, commercially available MIDI format files, etc. Not only can you play back a Song and listen to it, but you can also play the keyboard along with Song playback and record your own performance as a Song.

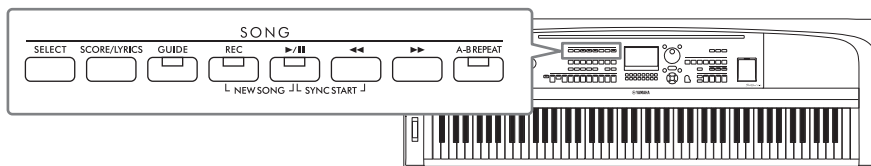

MIDI and Audio

There are two kinds of data that can be recorded and played back on this instrument: MIDI Songs and audio files. A MIDI Song is comprised of your keyboard performance information and is not a recording of the actual sound itself. The performance information refers to which keys are played, at what timing, and at what strength—just as in a musical score. Based on the recorded performance information, the tone generator outputs the corresponding sound. Since MIDI Song data contains the information such as keyboard part and Voice, you can practice effectively by viewing the score, turning the particular part on or off, or changing Voices.

An audio file is a recording of the performed sound itself. This data is recorded in the same way as that used with voice recorders, etc. Audio data in WAV format can be played back on this instrument just like playing it on your smartphone or portable music player, etc.

NOTE

For instructions on playback and recording of audio files, refer to page 72.

Playback of Songs

You can play back the following types of Songs.

- Preset Songs (in the **Preset** tab of the Song Selection display)
- Your own recorded Songs (page 68)
- Commercially available Songs: SMF (Standard MIDI File)

NOTE

For information on compatible MIDI formats, refer to page 106.

If you want to play back a Song in a USB flash drive, connect the USB flash drive containing the Song data to the [USB TO DEVICE] terminal beforehand.

NOTE

Before using a USB flash drive, be sure to read “Connecting USB Devices” on page 91.

1 Press the SONG [SELECT] button to call up the Song Selection display.

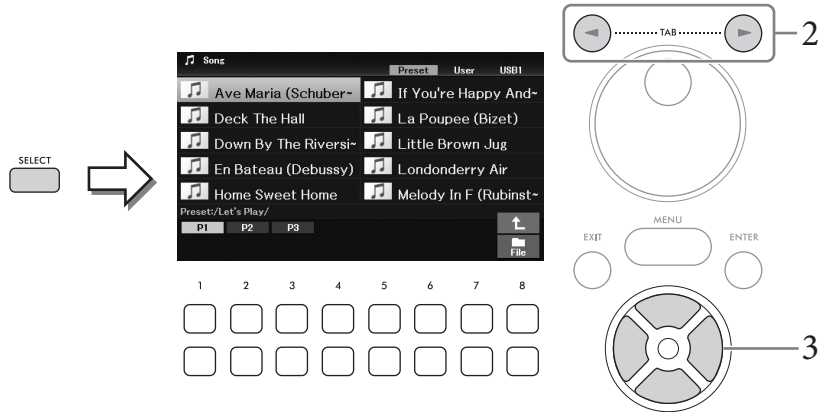

2 Use the TAB [◀][▶] buttons to select the location (Preset, User or USB1) of the desired Song.

NOTE

- The *USB1* tab appears only when a USB flash drive is connected to the [USB TO DEVICE] terminal.
- The *PianoRoom* folder in the *User* tab contains the Songs recorded in the Piano Room (page 37).

3 Select the desired Song by using the Cursor buttons [▲][▼][◀][▶].

4 Press the SONG [▶/||] (Play/Pause) button to start playback.



Queuing the next Song for playback

While a Song is playing back, you can queue up the next Song for playback. This is convenient for chaining it to the next Song smoothly during live performance. Select the Song you want to play next in the Song Selection display, while a Song is playing back. The “*Next*” indication appears at the upper right of the corresponding Song name. To cancel this setting, press the [7▼] (*Next Cancel*) button.

NOTE

If the button is not shown, press the [8▼] (*Close*) button to call it up.

When the selected Song reaches the end, playback stops automatically.

NOTE

If you wish to play Songs repeatedly without stopping, change the Repeat Mode as desired. For details, refer to page 67.

Playback-related Operations



■ Pause

Press the [▶/||] (Play/Pause) button during playback. Pressing it again resumes Song playback from the current position.

■ Synchro Start

You can start playback as soon as you play the keyboard. While playback is stopped, press the [▶/||] (Play/Pause) button and the [◀◀] (Rewind) button simultaneously. The [▶/||] (Play/Pause) button flashes, indicating the standby status. To cancel the Synchro Start function, repeat the same operation.

■ Rewind/Fast Forward

Hold the [◀◀] (Rewind) or [▶▶] (Fast forward) button during playback or while the Song is paused to move backward/forward continuously. Pressing the [◀◀] (Rewind) button during playback or while the Song is paused jumps back to the top position of the Song.

Holding (or pressing) the [◀◀] (Rewind) or [▶▶] (Fast forward) button calls up a pop-up display showing the current measure number (or Phrase Mark number). While the Song Position pop-up is shown on the display, you can also use the Data dial to adjust the value.

NOTE

Phrase Mark is a pre-programmed marker in certain Song data, which indicates a specific location in the Song.

For Songs not containing Phrase Marks



For Songs containing Phrase Marks



To change the units used in rewinding/fast-forwarding the Song from *Bar* to *Phrase Mark*, press one of the [3▲▼]/[4▲▼] buttons. To rewind/fast forward it in *Bar* units again, press one of the [1▲▼]/[2▲▼] buttons.

■ Adjusting the tempo

Same procedure as with Style tempo. See page 52.

■ Adjusting the volume balance among Song, Style and Keyboard

You can adjust the volume balance among the keyboard parts (Main, Layer, Left), the Style, the Song, the USB Audio Player, the Audio, the microphone sound, and the Audio Input Sound from the external device (page 95). These can be adjusted in the *Volume/Pan* tab on the *Mixer* display. See page 88.

■ Transpose the Song playback

See page 44.

Displaying Music Notation (Score)

You can view the music notation (score) of the selected Song. This feature is available not only for the score of the preset Songs, but also for the Songs you've recorded as well as commercially available MIDI files (only those which allow devices to indicate notation).

1 Select a Song (steps 1 – 3 on page 61).

2 Press the SONG [SCORE/LYRICS] button to call up the Score display.

If the Score display is not shown, press the [SCORE/LYRICS] button again. Pressing the button toggles between the Score and Lyrics displays.

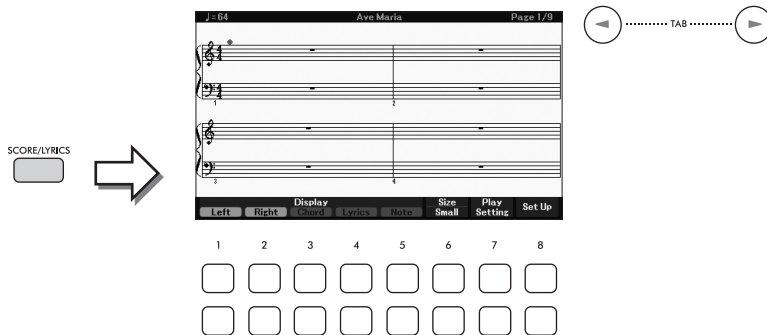

You can look through the entire notation by using the TAB [◀][▶] buttons when the Song playback is stopped. As Song playback starts, the “ball” bounces along through the score, indicating the current position.

NOTE

- The displayed notation is generated by the instrument based on the Song data. As a result, it may not be exactly the same as commercially available sheet music of the same song — especially when displaying notation of complicated passages or many short notes.
- You can turn to the next/previous score page by assigning the function to a pedal: [MENU] → Cursor buttons [▲][▼][◀][▶] Controller, [ENTER] → TAB [◀] Pedal. For details, refer to the Reference Manual on the website, Chapter 9.

You can change the displayed notation style such as the size by using the [1▲▼] – [8▲▼] buttons. For details, refer to the Reference Manual on the website.

Displaying Lyrics

When the selected Song contains lyrics data, you can view it on the instrument's display.

1 Select a Song (steps 1 – 3 on page 61).

2 Press the SONG [SCORE/LYRICS] button to call up the Lyrics display.

If the Lyrics display is not shown, press the [SCORE/LYRICS] button again. Pressing the button toggles between the Score and Lyrics displays.

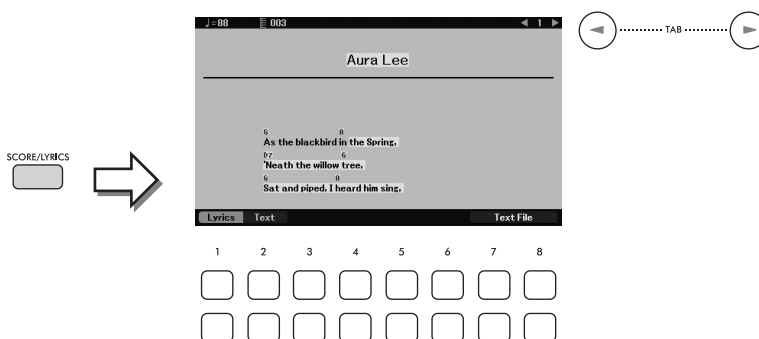

When the Song data contains lyrics data, the lyrics are shown on the display. You can look through the entire lyrics by using the TAB [◀][▶] buttons when Song playback is stopped. As Song playback starts, the color of the lyrics changes, indicating the current position.

NOTE

- When the lyrics are garbled or unreadable, you may need to change the language setting: [MENU] → Cursor buttons [▲][▼][◀][▶] *Song Setting*, [ENTER] → TAB [▶] *Setting* → Cursor button [▼] 2 *Lyrics Language*.
- You can turn to the next/previous lyrics or text page by assigning the function to a pedal: [MENU] → Cursor buttons [▲][▼][◀][▶] *Controller*, [ENTER] → TAB [◀] *Pedal*. For details, refer to the Reference Manual on the website, Chapter 9.

Displaying Text

Regardless of whether a Song is selected or not, you can view the text file (.txt) created by using a computer on the instrument's display. Text display allows for a variety of useful and convenient possibilities, such as the showing of lyrics, chord names, and performance notes.

You can switch between the Lyrics display and the Text display by using the [1▲▼] (*Lyrics*)/[2▲▼] (*Text*) buttons. To view a text file on the Text display, press one of the [7▲▼]/[8▲▼] (*Text File*) buttons to call up the File Selection display, and then select the desired file in the connected USB flash drive.

For more information about the Lyrics/Text displays, refer to the Reference Manual on the website.

Turning Each Channel of the Song On/Off

A Song consists of 16 separate channels. Usually, keyboard parts are assigned to channels 1 – 3 and Style parts are assigned to channels 9 – 16. You can independently turn each channel of the selected Song playback on or off.

- 1 Press the [CHANNEL ON/OFF] button several times to call up the *Channel On/Off (Song)* display.

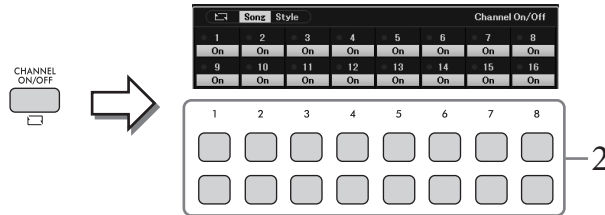

- 2 Use the [1▲▼] – [8▲▼] buttons to turn each channel on or off.
If you want to play back only one particular channel (solo playback), hold down one of the [1▲▼] – [8▲▼] buttons to set the desired channel to *Solo*. Only the selected channel is turned on and others are off. To cancel solo playback, press the same button again.
- 3 Press the [EXIT] button to close the *Channel On/Off (Song)* display.

One-handed Practice with the Guide Function

You can mute the right-hand part for practicing that part on your own while you view the notes to play in the Score display. The explanations here apply when you practice the right-hand part with *Follow Lights* of the Guide functions. You can practice at your own pace — since the accompaniment waits for you to play the notes correctly.

- 1 Select a Song and call up the Score display (steps 1 – 2 on page 63).
- 2 Press the SONG [GUIDE] button to turn it on.

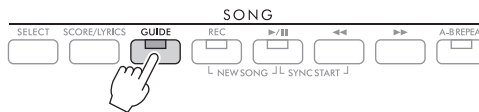

3 Use the [7▲▼] (*Play Setting*) buttons to call up the *Play Setting* window.

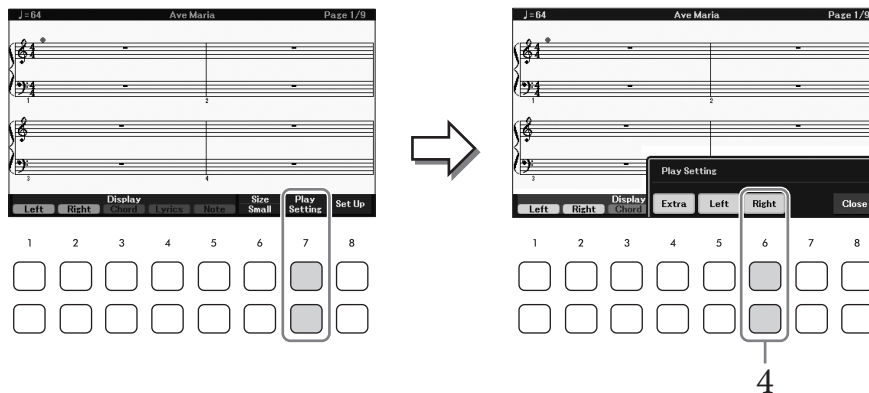

4 Use the [6▲▼] (*Right*) buttons to turn off the right-hand part, and then use the [8▲▼] buttons to close the window.

The right-hand part is muted and the Guide for the right-hand part is enabled. You can now play that part by yourself.

NOTE

- If necessary, use the [4▲▼] (*Extra*) buttons to mute the extra parts.
- Usually, channel 1 is assigned to the right-hand part and channel 2 is assigned to the left-hand part, but you can change which channel is assigned to each part via [MENU] → Cursor buttons [▲][▼][◀][▶] *Song Setting*, [ENTER] → TAB [▶] *Setting* → Cursor button [▲] *1 Part Channel*.

■ For left-handed practice:

Turn off the left-hand part by using the [5▲▼] (*Left*) buttons.

■ For both-handed practice:

Turn off both right- and left-hand parts by using the [6▲▼] (*Right*) and [5▲▼] (*Left*) buttons.

Make sure to turn the [ACMP] button off when practicing the Left part, otherwise the Guide function for the Left part does not work.

5 Press the SONG [▶/||] (*Play/Pause*) button to start playback.



Practice the right-hand part while viewing the Score display. The playback of the left and extra parts will wait for you to play the notes correctly.

6 After your practice, turn the [GUIDE] button off.

Other Guide functions

In addition to the *Follow Lights* function explained above, there are more functions in the Guide features, for practicing the timing of playing the keys (*Any Key*), for Karaoke or for practicing a Song at your own pace (*Your Tempo*). This can be selected in the display called up via [MENU] → Cursor buttons [▲][▼][◀][▶] *Song Setting*, [ENTER] → TAB [▶] *Setting* → Cursor button [▲] *1 Guide Mode*. For more information, refer to the Reference Manual on the website.

Repeat Playback

The Song Repeat functions can be used to repeatedly play back a Song, multiple Songs, or a specific range of measures in a Song.

Selecting the Repeat Mode for Song playback

1 Call up the operation display.

[MENU] → Cursor buttons [▲][▼][◀][▶] *Song Setting*, [ENTER] → TAB [◀] *Play* → Cursor button [▲] *1 Repeat Mode*

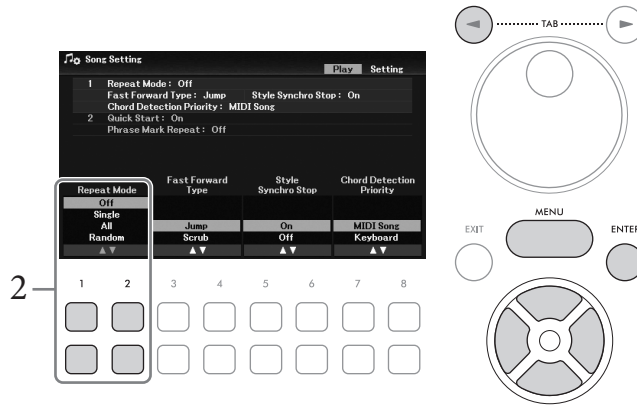

2 Use the [1▲▼]/[2▲▼] (*Repeat Mode*) buttons to determine the method of repeat playback.

- **Off:** Plays through the selected Song, and then stops.
- **Single:** Plays through the selected Song repeatedly.
- **All:** Continues playback through all the Songs in the specified folder repeatedly.
- **Random:** Continues playback at random through all the Songs in the specified folder repeatedly.

Specifying a Range of Measures and Playing them Back Repeatedly (A-B Repeat)

1 Select a Song (steps 1 – 3 on page 61).

2 Press the SONG [▶/||] (Play/Pause) button to start playback.

3 Specify the repeat range.

Press the [A-B REPEAT] button at the starting point (A) of the range to be repeated. (The lamp flashes, indicating point A has been specified.) Press the [A-B REPEAT] button again at the ending point (B). (The lamp lights continuously.) After an automatic lead-in (to help guide you into the phrase), the range from Point A to Point B is played back repeatedly.

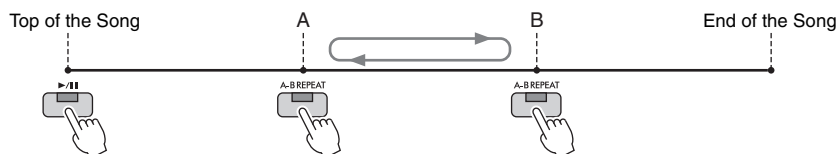

NOTE

- Specifying only Point A results in repeat playback between Point A and the end of the Song.
- When you want to repeat from the top of the Song to a specified point in the middle:
 1. Press the [A-B REPEAT] button, and then start Song playback.
 2. Press the [A-B REPEAT] button again at the ending point (B).

4 Practice the specified range by playing the keyboard along with the Song repeatedly.

After your practice, press the [A-B REPEAT] button to turn it off.

Specifying the repeat range while Songs are stopped

1. Fast-forward the Song to Point A by using the [▶▶] (Fast forward) button, and then press the [A-B REPEAT] button.
2. Fast-forward the Song to Point B, and then press the [A-B REPEAT] button again.

Recording Your Performance

You can record your performance and save it as a MIDI file (SMF format 0) to the User drive or USB flash drive. Since the recorded data is MIDI, you can independently record the right- and left-hand parts, or re-record a specific section and edit other settings (such as Voice) after saving the data.

NOTE

- Audio data such as the sound input from the [MIC INPUT] and [AUX IN] jacks, etc. cannot be recorded to the MIDI Songs. If you want to record such data, use the USB Audio Recorder function (page 75).
- Before using a USB flash drive, be sure to read "Connecting USB Devices" on page 91.

Recording All Parts at a time (Quick Recording)

This simple method lets you start recording immediately without specifying the parts or channels you want to record to. For Quick Recording, each part will be recorded to the following channels.

- Keyboard parts: channels 1 – 3 (Main: channel 1, Left: channel 2, Layer: channel 3)
- Style parts: channels 9 – 16

- 1 Make necessary settings such as turning on the desired PART ON/OFF button and selecting the desired Voice, etc.
- 2 Press the SONG [REC] button and the [▶/||] (Play/Pause) button simultaneously. A blank Song for recording is automatically set. A blank Song for recording is automatically set, and the Song name on the Main display (page 23) is set to "New Song."

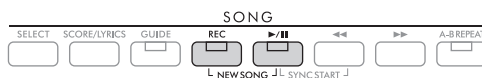

- 3 Press the [REC] button.

The [REC] and [▶/||] (Play/Pause) buttons flash, indicating the standby status.

NOTE

If you want to cancel recording, press the [REC] button before going on to the next step.

4 Start recording.

You can start recording by playing the keyboard, starting a Style or pressing the SONG [▶/||] (Play/Pause) button.



NOTE

You can use the metronome (page 44) while recording; however, the metronome sound will not be recorded.

5 After you finish your performance, press the [REC] button again to stop recording.

A message may appear prompting you to save the recorded data. Press the [EXIT] button to close the message.

To hear the recorded performance, press the [▶/||] (Play/Pause) button.

6 To hear the recorded performance, press the [▶/||] (Play/Pause) button.

7 Save the recorded performance as a Song.

7-1 Press the SONG [SELECT] button to call up the Song Selection display.

7-2 Save the recorded data as a file by following the instructions on page 26.

NOTICE

The recorded Song will be lost if you change to another Song or you turn the power off without executing the Save operation.

Re-recording a Specific Section of the Song

You can re-record a specific section of an already-recorded Song by using the Song Creator function. For details, refer to the Reference Manual on the website.

Recording Specified Parts or Channels Independently

A Song consists of 16 channels, and, in general, the keyboard parts and Style parts are assigned (recorded) to each channel as described below.

Part	Keyboard			Style							
	Main	Layer	Left	Rhythm 1	Rhythm 2	Bass	Chord 1	Chord 2	Pad	Phrase 1	Phrase 2
Channel	1	2	3	9	10	11	12	13	14	15	16

You can create a Song by recording each part (or channel) independently, allowing you create a complete piece which may be difficult to play live. For example, you can record the right-hand part to channel 1 and then record the left-hand part to channel 2 while listening to the already recorded right-hand part. To record a performance with Style playback, for example, record the Style playback to channels 9 – 16, and then record melodies to channels 1 – 3 while listening to the already recorded Style playback.

- 1 Make necessary settings such as turning on the desired PART ON/OFF button and selecting the desired Voice, etc.
- 2 Press the SONG [REC] button and the [▶/||] (Play/Pause) button simultaneously. A blank Song for recording is automatically set. A blank Song for recording is automatically set, and the Song name on the Main display (page 23) is set to “New Song.”

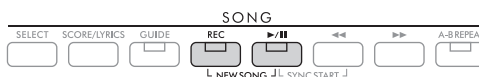

- 3 While holding down the [REC] button, press the appropriate [1▲▼] – [8▲▼] buttons to set the desired channels to “Rec.”

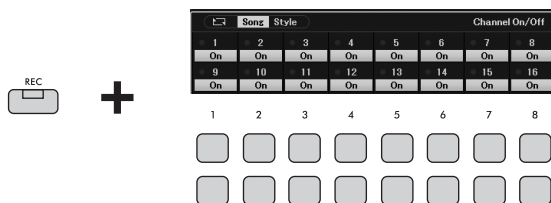

When the channel is set to Rec, the following window which indicates the part assignment for the selected channel will appear.



If necessary, use the Data dial to change the part assignment for the channel to be recorded. To cancel the “Rec” status of the channel, press the desired channel button.

NOTICE

Previously recorded data will be overwritten if you set channels which have recorded data to Rec.

NOTE

If you want to cancel recording, press the [REC] button before going on to the next step.

- 4 Start recording.

You can start recording by playing the keyboard, starting a Style or pressing the SONG [▶/||] (Play/Pause) button.

When you are overdubbing to a recorded Song, start recording by pressing the SONG [▶/||] (Play/Pause) button so that you can record while listening to the already recorded data.

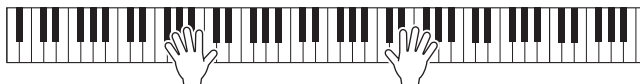

- 5 After you finish your performance, press the [REC] button again to stop recording.

A message may appear prompting you to save the recorded data. Press the [EXIT] button to close the message.

To hear the recorded performance, press the [▶/||] (Play/Pause) button.

- 6 Record your performance to another channel by repeating steps 3 to 5 above.

Deleting a Specific Channel of the Song

You can delete the data of the specified channel in the Song by using the Song Creator function. For details, refer to the Reference Manual on the website.

- 7 Save the recorded performance as a Song.

7-1 Press the SONG [SELECT] button to call up the Song Selection display.

7-2 Save the recorded data as a file by following the instructions on page 26.

NOTE

The recorded Song will be lost if you change to another Song or you turn the power off without executing the Save operation.

Advanced Features

Refer to the Reference Manual on the website, Chapter 4.



Editing Music Notation (Score) settings:	[SCORE/LYRICS] (Score display) → [1▲▼]-[8▲▼] buttons
Editing Lyrics/Text display settings:	[SCORE/LYRICS] (Lyrics/Text display) → [1▲▼]-[8▲▼] buttons
Using the Auto Accompaniment features with Song playback:	SONG [▶/] (Play/Pause) + [◀◀] (Rewind) → STYLE CONTROL [SYNC START] → STYLE CONTROL [START/STOP]
Song playback related parameters:	[MENU] → Cursor buttons [▲][▼][◀][▶] <i>Song Setting</i> , [ENTER] → TAB [◀][▶] <i>Play</i> or <i>Setting</i>
Editing Songs (Song Creator):	[MENU] → Cursor buttons [▲][▼][◀][▶] <i>Song Creator</i> , [ENTER]
• Selecting the setup data to be recorded to the top position of the Song:	→ TAB [◀][▶] <i>Setup</i>
• Re-recording a specific section —Punch In/Out:	→ TAB [◀] <i>Rec Mode</i>
• Editing channel events:	→ TAB [▶] <i>Channel</i> → Cursor buttons [▲][▼][◀][▶] <i>Quantize/Delete/Mix/Transpose</i> , [ENTER]

5 USB Audio Player/Recorder

– Playback and Recording Audio Files –

The convenient USB Audio Player/Recorder function allows you to play back audio files (.wav) saved to a USB flash drive — directly from the instrument. Moreover, since you can record your performances and recordings as audio files (.wav) to a USB flash drive, it is possible to play back the files on computer, share them with your friends, and record your own CDs to enjoy as well.

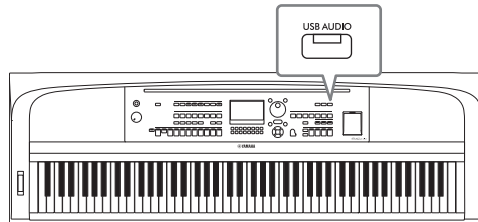

NOTE

For instructions on playback and recording of MIDI files, refer to page 60.

Playing Back Audio Files (USB Audio Player)

You can play back audio files of WAV format (44.1 kHz sample rate, 16-bit resolution, stereo) that have been saved to the USB flash drive.

NOTE

DRM (Digital Rights Management) protected files cannot be played back.

- 1 **Connect the USB flash drive containing the audio files to the [USB TO DEVICE] terminal.**

NOTE

Before using a USB flash drive, be sure to read "Connecting USB Devices" on page 91.

- 2 **Press the [USB AUDIO] button to call up the *USB Audio Player* display.**

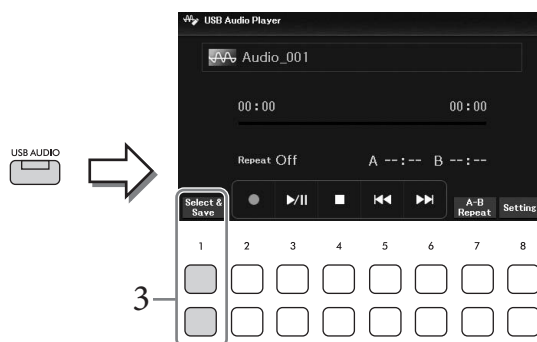

- 3 **Press one of the [1▲▼] (*Select & Save*) buttons to call up the Audio File Selection display.**

4 Select the desired file by using the Cursor buttons [▲][▼][◀][▶].

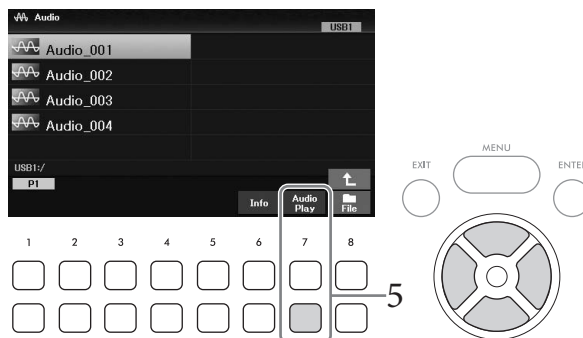

NOTE

Audio files take a slightly longer time to load than other files.

Viewing Audio file information

Pressing the [6▼] (*Info*) button calls up the Information window from which you can view the file name, sample rate etc. of the selected file.

NOTE

If the button is not shown, press the [8▼] (*Close*) button to call it up.

5 Press the [7▼] (*Audio Play*) button to start playback.

The display automatically returns to the *USB Audio Player* display.

NOTE

If the button is not shown, press the [8▼] (*Close*) button to call it up.

6 To stop playback, use the [4▼▲] (■) buttons.

NOTICE

Never attempt to disconnect the USB flash drive or turn the power off during playback. Doing so may corrupt the USB flash drive data.

Playback-related Operations

[3▲▼]	▶/ (Play/Pause)	Starts or pauses playback at the current position.
[4▲▼]	■ (Stop)	Stops playback.
[5▲▼]	◀◀ (Prev.)	Pressing this changes the file to the previous one; holding it moves continuously back through the current file (in seconds).
[6▲▼]	▶▶ (Next)	Pressing this changes the file to the next one; holding it moves continuously forward through the current file (in seconds).
[7▲▼]	<i>A-B Repeat</i>	Just as with Songs in MIDI format (page 67), audio files can also be played back repeatedly within the specified section (between the A and B points). During playback, press this button at the starting point (A), and then press the button again at the ending point (B) to start repeat playback between the A and B points. To cancel this setting, press this button again.
[8▲▼]	<i>Setting</i>	Calls up the setting window in which you can set the audio playback related parameters such as Vocal Cancel, Time Stretch and Pitch Shift. For details, see the next page.

■ USB Audio Player Setting

The window called up by using the [8▲▼] (*Setting*) buttons on the *USB Audio Player* display allows you to make detailed settings related to Audio playback.

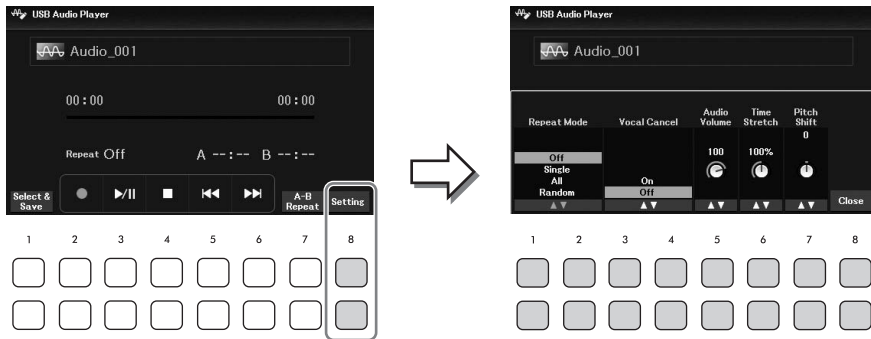

[1▲▼]/ [2▲▼]	Repeat Mode	<p>Selects the repeat mode of Audio playback.</p> <ul style="list-style-type: none"> • Off: Plays through the selected file, and then stops. • Single: Plays through the selected file repeatedly. • All: Continues playback through all the files in the folder containing the current file repeatedly. • Random: Randomly and repeatedly plays back all files in the folder containing the current file.
[3▲▼]/ [4▲▼]	Vocal Cancel	<p>The Vocal Cancel function cancels or attenuates the center position of the stereo sound. This lets you sing “karaoke” style with just instrumental backing, or play the melody part on the keyboard, since the vocal sound is usually at the center of the stereo image in most recordings.</p> <p>First select an Audio file, and then turn the Vocal Cancel function on/off by pressing this button.</p> <p>NOTE</p> <ul style="list-style-type: none"> • Though the Vocal Cancel function is highly effective on most audio recordings, the vocal sound on some songs may not be completely canceled. • Vocal cancel does not affect the Audio Input Sound (page 95) from external devices.
[5▲▼]	Audio Volume	Adjusts the playback volume of an Audio file.
[6▲▼]	Time Stretch	<p>Adjusts the playback speed of an Audio file by stretching or compressing it. The value can be adjusted from 75% to 125% and the default value is 100%. Higher values result in a faster tempo. If you select another audio file, this setting will be restored to the default value.</p> <p>NOTE</p> <p>Changing the playback speed of an Audio file may change its tonal characteristics.</p>
[7▲▼]	Pitch Shift	Shifts the pitch of an Audio file in semitone steps (from -12 to 12). If you select another audio file, this setting will be restored to the default value.

To close the window, use the [8▲▼] (*Close*) buttons.

Recording Your Performance as Audio (USB Audio Recorder)

You can record your performance as an audio file (WAV format — 44.1 kHz sample rate, 16-bit resolution, stereo) directly to a USB flash drive. This instrument allows you to record up to 80 minutes per single recording.

Sounds that can be recorded:

- All sounds produced by your performance (Main, Layer, Left, Song, Style)
- Microphone sound input from the [MIC INPUT] jack (page 77)
- Audio Input Sound from connected devices (page 95)

NOTE

- If you want to record each part separately, or edit the recorded data after saving, record the data as a MIDI Song (page 68).
- To record your keyboard performance and microphone sound separately, record your keyboard performance as a MIDI Song (page 68), and then record the microphone sound by using the USB Audio Recorder function.

1 Connect the USB flash drive to the [USB TO DEVICE] terminal.

NOTE

Before using a USB flash drive, be sure to read “Connecting USB Devices” on page 91.

2 Make the necessary settings such as Voice/Style selection.

3 Press the [USB AUDIO] button to call up the *USB Audio Player* display.

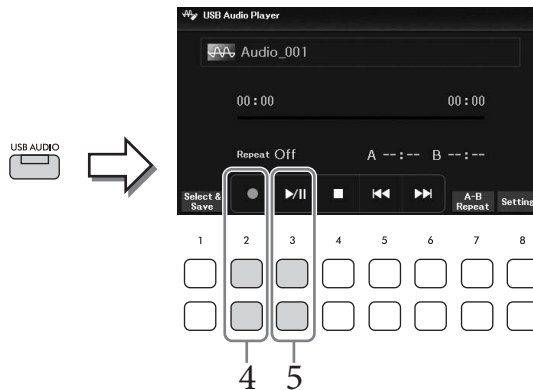

4 Use the [2▲▼] (●) buttons to enter recording standby.

NOTE

You can use the metronome (page 44) while recording; however, the metronome sound will not be recorded.

5 Start recording by using the [3▲▼] (▶/||) buttons, and then start your performance.

The elapsed recording time is shown in the display while recording.

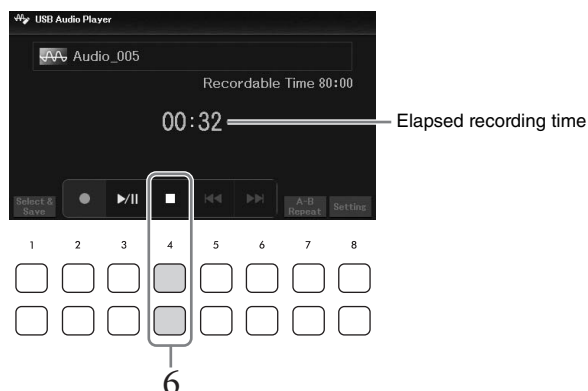

NOTICE

Never attempt to disconnect the USB flash drive or turn the power off during recording. Doing so may corrupt the USB flash drive data or the recording data.

6 After you finish your performance, use the [4▲▼] (■) buttons to stop recording.

Recorded data is automatically saved to the USB flash drive as a file with the name automatically set.

NOTE

The recording operation continues, even if you close the *USB Audio Player* display by pressing the [EXIT] button. Press the [USB AUDIO] button to call up the *USB Audio Player* display again, and then stop the recording by using the [4▲▼] (■) buttons.

7 Use the [3▲▼] (▶/||) buttons to play back the recorded performance.

To see the file of the recorded performance in the Audio File Selection display, use the [1▲▼] (*Select & Save*) buttons.

NOTE

Keep in mind that if you make a mistake in your performance, you cannot correct it by overwriting an existing file. Delete the recorded file on the File Selection display, and then record your performance again.

6 Microphone

– Connecting a Microphone and Singing Along with Your Performance –

By connecting a microphone to the [MIC INPUT] jack, you can enjoy singing along with your keyboard performance or with Song/Audio playback. The instrument outputs your vocals through the built-in speakers.

Connecting a Microphone

- 1 Before turning on the power of the instrument, turn down the [MASTER VOLUME] dial to the minimum position.
- 2 Connect the microphone to the [MIC INPUT] jack.

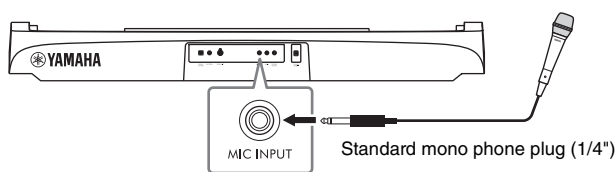

- 3 Turn on the power of the instrument, and then adjust the volume by using the [MASTER VOLUME] dial.
- 4 Call up the operation display.
[MIC SETTING] → TAB [◀] Mixer

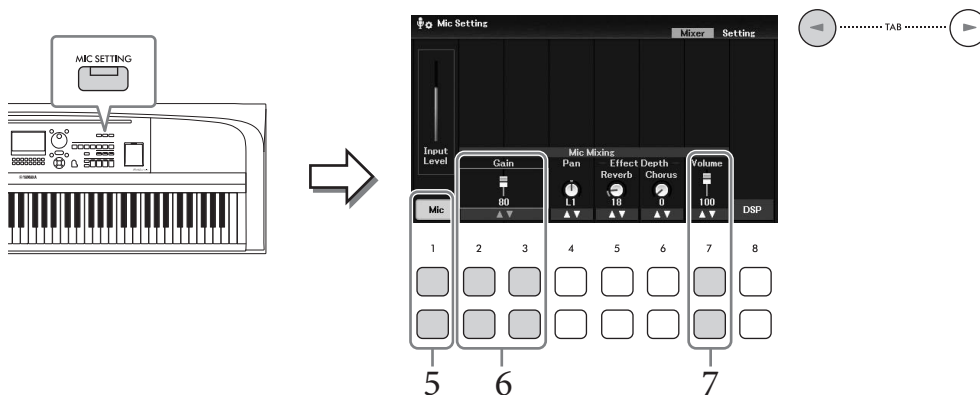

- 5 Make sure that *Mic* (the [1▲▼] buttons) is turned on.
If necessary, also turn on the power of the connected microphone.
- 6 Adjust the input level by using the [2▲▼]/[3▲▼] (*Gain*) buttons while singing into the microphone.

Adjust the level while checking the *Input Level* meter on the left. Make sure to adjust it so the meter lights in yellow or green. When the input level is too high, it lights in red.

7 Adjust the volume balance between the microphone sound and the instrument sound by using the [7▲▼] (*Volume*) buttons.

If necessary, also adjust the stereo pan position of the microphone sound by using the [4▲▼] (*Pan*) buttons.

Disconnecting the microphone

1. Turn down the [MASTER VOLUME] dial to “MIN.”
2. Disconnect the microphone from the [MIC INPUT] jack.

■ Useful Functions for Karaoke Singing

- When using the Songs: Lyrics on the display (page 64), Transpose (page 44)
- When using the Audio files: Vocal Cancel (page 74), Pitch Shift (page 74)

Applying Effects to Your Singing Voice

You can apply various effects (such as Reverb and Chorus) to your singing voice that is input to the microphone.

On the *Mixer* tab of the *Mic Setting* display (step 4 on page 77), use the [5▲▼] (*Reverb*) buttons or [6▲▼] (*Chorus*) buttons to adjust the Reverb Depth or the Chorus Depth while singing into the microphone. These effects are applied to the entire instrument (keyboard parts, Song and Style) as well as the microphone. If you want to apply effects only to the microphone sound, you can specify the part and select the effect type via the [8▲▼] (*DSP*) buttons. For details, refer to the Reference Manual on the website.

Using the Talk Function

This function lets you instantly change the microphone settings for talking or making announcements between song performances.

- 1 Call up the operation display.
[MIC SETTING] → TAB [▶] *Setting*

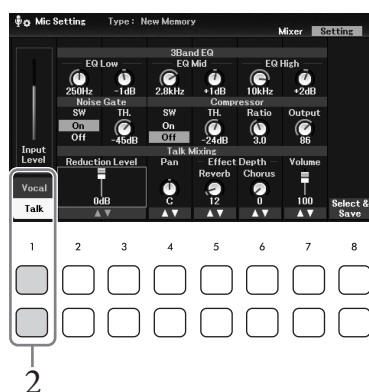
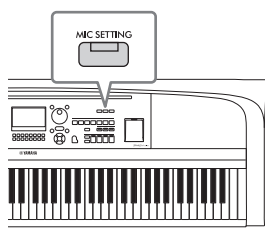

- 2 Press the [1▼] (*Talk*) button to call up the Talk settings.

To turn the Talk function off and recall the settings for singing, press the [1▲] (*Vocal*) button. From these displays, you can adjust the microphone settings for singing (*Vocal*) and talking (*Talk*) independently. For details, refer to the Reference Manual on the website.

Advanced Features

Refer to the Reference Manual on the website, Chapter 6.



Making and saving the microphone settings:

[MIC SETTING] → TAB [▶] *Setting*

Applying desired Effect to the microphone sound:

[MIC SETTING] → TAB [◀] *Mixer* → [8▲▼] (*DSP*)

7 Registration Memory/Playlist

– Saving and Recalling Custom Panel Setups –

The Registration Memory function allows you to save (or “register”) panel settings such as Voice and Style to a Registration Memory button, and then instantly recall your custom panel settings by simply pressing a single button. When you’ve saved lots of data to the Registration Memory, use the Playlist to manage your repertoire so that you can quickly call up the desired Registration Memory for each piece of music.

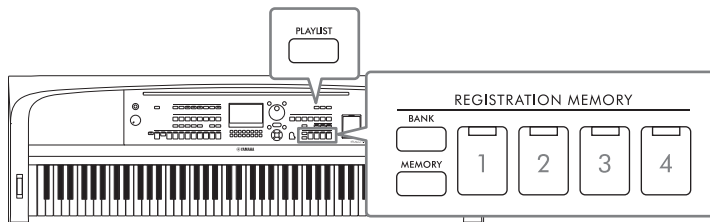

■ Registration Memory (page 81)

You can register your custom panel settings to each of the REGISTRATION MEMORY [1] – [4] buttons. You can also save all four registered panel setups as a single Registration Memory Bank file. If you select a Registration Memory Bank file beforehand, you can easily call up the registered settings simply by pressing a button during your performance.

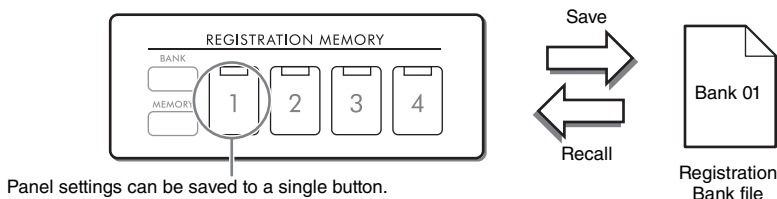

■ Playlist (page 84)

The Playlist function allows you to create custom performance lists. A Playlist contains links to call up Registration Memory Bank files for each piece you play. Each link to the Registration Memory is called a “Record,” and you can collectively store the Playlist Records as a single Playlist file. Each Playlist Record can directly recall a specified Registration Memory number in the selected Registration Memory Bank file. By using the Playlist, you can select only the desired files from the huge number of the Registration Memory Bank files without changing the bank file configuration.

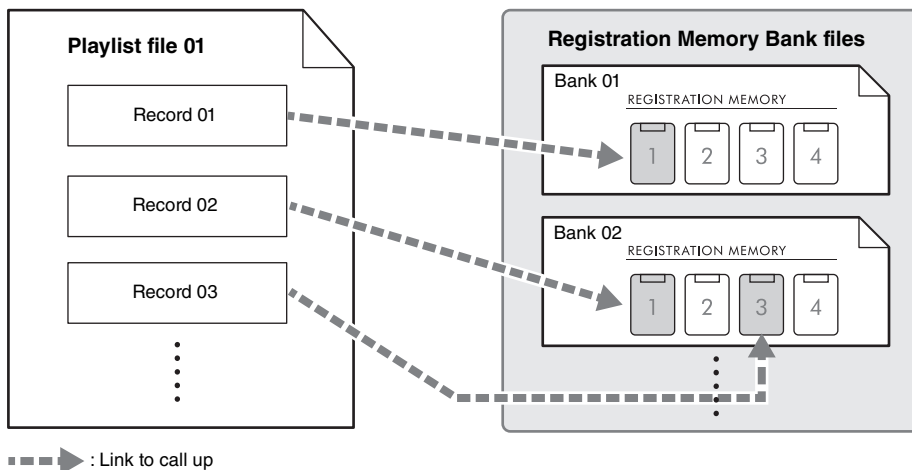

Saving and Recalling Custom Panel Setups with Registration Memory

Registering Your Panel Setups

- 1 **Make the desired panel settings, such as those for Voices, Styles and Effects.**
Refer to *Parameter Chart* in the Data List on the website for a list of parameters that can be registered with the Registration Memory function.
- 2 **Press the REGISTRATION MEMORY [MEMORY] button to call up the *Registration Memory* window.**

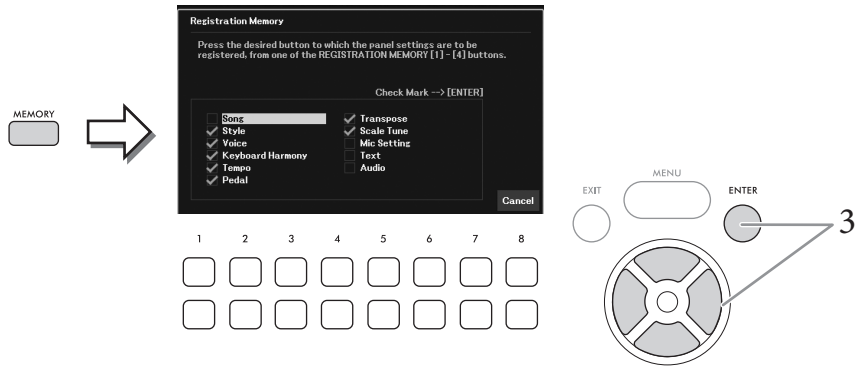

- 3 **Use the Cursor buttons [▲][▼][◀][▶] to select the item to be registered, and then press the [ENTER] button to enter (or remove) the corresponding checkmark.**
To cancel the operation, use the [8▲▼] (*Cancel*) buttons.

NOTE

You can also use the Data dial to select the items.

- 4 **Press the desired REGISTRATION MEMORY [1] – [4] button to which you wish to memorize the panel setup.**



Memorized buttons are lit in orange, indicating that the number button contains data and its number is selected.

NOTICE

If you select the button whose lamp is lit in orange or green here, the panel setup previously memorized to the button will be erased and replaced by the new settings. Hence, you should memorize panel setups only to buttons that are turned off.

About the lamp status

- **Orange:** Data registered and currently selected
- **Green:** Data registered but not currently selected
- **Off:** No data registered

5 Register various panel setups to other buttons by repeating steps 1 – 4.

The registered panel setups can be recalled by simply pressing the desired number button.

NOTE

The panel setups registered in the numbered buttons are maintained even when you turn off the power. If you want to delete all the four current panel setups, turn the power on while holding the B6 key (right-most B key on the keyboard).

Saving the Registration Memory as a Bank File

All of the panel settings are registered to the four Registration Memory buttons as a single Bank file.

- 1 Press the REGISTRATION MEMORY [BANK] button to call up the Registration Bank Selection display.

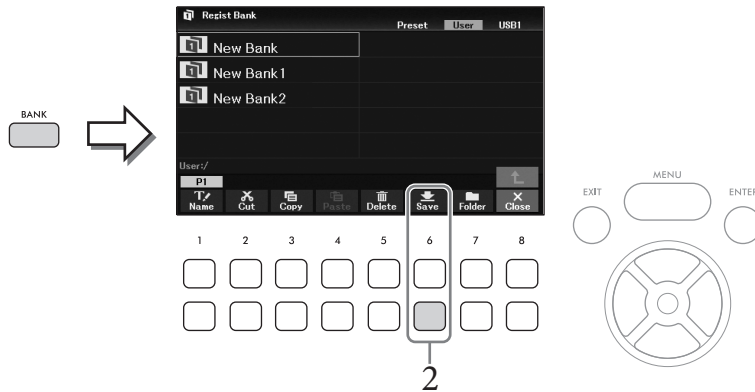

- 2 Press the [6▼] (Save) button to save the Bank file by following the instructions on page 26.

NOTE

If the button is not shown, press the [8▼] (File) button to call it up.

Recalling a Registered Panel Setup

The saved Registration Memory Bank files can be recalled by the following procedure.

NOTE

When recalling the setups including file selection of Song, Style, text etc. from a USB flash drive, make sure that the appropriate USB flash drive including the registered Song, Style or text is connected into the [USB TO DEVICE] terminal. Before using a USB flash drive, be sure to read "Connecting USB Devices" on page 91.

- 1 Press the REGISTRATION MEMORY [BANK] button to call up the Registration Bank Selection display.

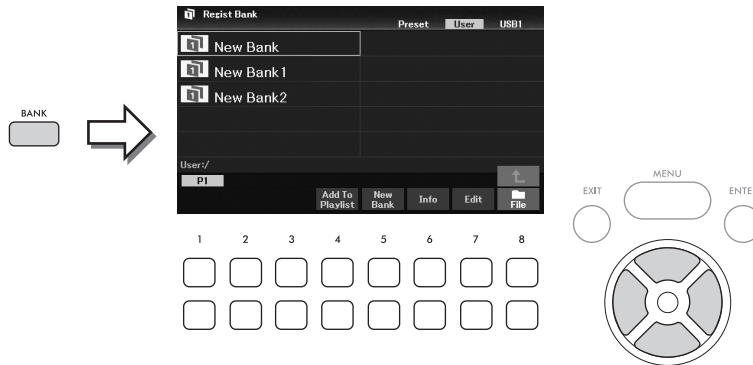

- 2 Select the desired Bank by using the Cursor buttons [▲][▼][◀][▶].

Viewing Registration Bank information

You can call up the information window to confirm which Voices and Style are memorized to the [1] – [4] buttons of a Registration Memory Bank by pressing the [6▼] (*Info*) button.

NOTE

If the button is not shown, press the [8▼] (*Close*) button to call it up.

NOTE

You can add the selected Bank file to the current Playlist (page 84) as a Record via the [4▼] (*Add To Playlist*) button.

- 3 Press one of the green-lit numbered buttons (REGISTRATION MEMORY [1] – [4]).

NOTE

If you want to clear the current memory and create a new bank (i.e., all lamps of the REGISTRATION MEMORY buttons are turned off), press the [5▼] (*New Bank*) button on the display above.

Advanced Features

Refer to the Reference Manual on the website, Chapter 7.



Deleting or renaming the Registration Memory

[BANK] (→) [8▼] (*Close*) → [7▼] (*Edit*)

Disabling recall of specific items (Freeze):

[MENU] → Cursor buttons [▲][▼][◀][▶] *Regist Sequence/Freeze*,
[ENTER] → TAB [▶] *Freeze*

Calling up Registration Memory numbers in order (Registration Sequence):

[MENU] → Cursor buttons [▲][▼][◀][▶] *Regist Sequence/Freeze*,
[ENTER] → TAB [◀] *Registration Sequence*

Using Playlists to Manage a Large Repertoire of Panel Setups

The Playlist is useful for managing multiple set lists for your performances. You can select only the desired files from a large repertoire (the huge number of the Registration Memory Bank files) and create a new set list for each performance.

Adding a Record (Link to a Bank file) to a Playlist

By adding Records to a Playlist, you can directly recall desired Registration Memory Bank files from the Playlist for each performance.

- 1 Press the [PLAYLIST] button to call up the *Playlist* display. The Playlist file which was selected the last time appears. (The sample preset Playlist will appear for the first time.)

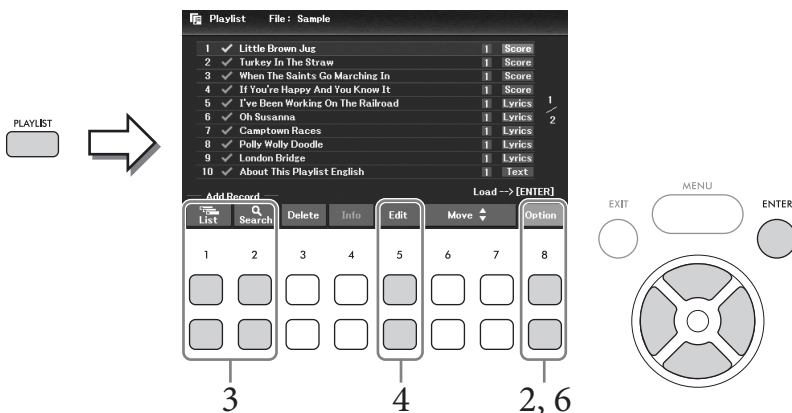

- 2 If you want to create a new Playlist, use the [8▲▼] (*Option*) button to call up the operation window, and then use the [3▲▼]/[4▲▼] (*Create New Playlist*) buttons to clear the list on the *Playlist* display.

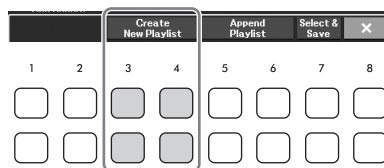

- 3 Add Records to the Playlist.

■ To add a Record via the Registration Bank Selection display:

- 3-1 Use the [1▲▼] (*List*) buttons to call up the Registration Bank Selection display.

The *Add To Playlist* window appears automatically.

- 3-2 Use the Cursor buttons [▲][▼][◀][▶] to select the desired Bank file to register as a Playlist Record, and then press the [ENTER] button.

If you want to select all files shown in the current folder including the other pages, press the [8▼] (*All*) button.

If you want to select a file that is not shown on the current page, press the [6▼] (*Cancel*) button to close the *Add To Playlist* window, and then select the page that contains desired file. After that, press the [4▼] (*Add To Playlist*) to call up the *Add To Playlist* window again.

3-3 Pressing the [7▼] (OK) button closes the display, and the new Records are added to the bottom of the Playlist.

■ To add a Record by using the search function:

3-1 Use the [2▲▼] (Search) buttons to call up the *Playlist Record Search* display.

3-2 If necessary, use the [1▲▼]/[2▲▼] (Update) buttons to update the data used for searching.

This operation is needed when new Registration Bank files are added or the USB flash drive containing Bank files is connected, in order to register these files as searching targets.

3-3 Enter the *Record Name* and/or *Tag* to search for the desired Registration Bank file, and then press one of the [7▲▼]/[8▲▼] (Search) buttons.

Tag includes information such as music genre names. Registration Bank files which contain Tag data can be searched by using Tag.

3-4 From the search result, use the Cursor buttons [▲][▼][◀][▶] to select the desired Bank file to register as a Playlist Record, and then press the [ENTER] button.

If you want to select all files, press the [8▼] (All) button.

3-5 Pressing the [7▼] (OK) button closes the display, and the new Records are added to the bottom of the Playlist.

4 If necessary, edit the Record.

The newly added Playlist Record simply recalls the selected registration Bank file. If you want to set more detailed settings (such as directly recalling a specified Registration Memory number), you can edit the Record.

4-1 Select the Record to be edited by using the Cursor buttons [▲][▼].

4-2 Press the [5▲▼] (Edit) buttons to call up the *Playlist Record Edit* window.

4-3 Use the Cursor buttons [▲][▼] to select the item to be edited.

File path of the Registration Bank file linked to the Record. This file will be recalled by selecting the Record.

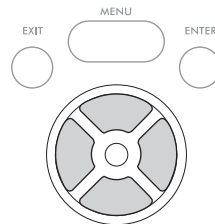

Record Name	Determines the name of the Record. Pressing the [ENTER] button calls up the Character Entry window and lets you edit the name.
Action	<p>Additional actions after selecting the Record and recalling the Bank. Use the Data dial to change the settings.</p> <ul style="list-style-type: none"> • Load Regist Memory: Recalls the Registration Memory corresponding to the number selected here. When <i>Off</i> is selected, no Registration Memory is recalled. • View: Displays the view (score, lyrics or text) selected here. When <i>Off</i> is selected, no view is displayed. <p>NOTE These settings are shown at right of the Record name on the Playlist display.</p>

4-4 Press the [EXIT] button to close the *Playlist Record Edit* window.

If necessary, repeat step 4 to edit other records.

- 5 Save all Records as a single Playlist file.
 - 5-1 Use the [8▲▼] (*Option*) buttons to call up the operation window.
 - 5-2 Use the [7▲▼] (*Select & Save*) buttons to call up the Playlist File Selection display.
 - 5-3 Save the Records as a file by following the instructions on page 26.

Recalling Custom Panel Setups via the Playlist

- 1 From the Playlist display, use the [8▲▼] (*Option*) buttons to call up the operation window.

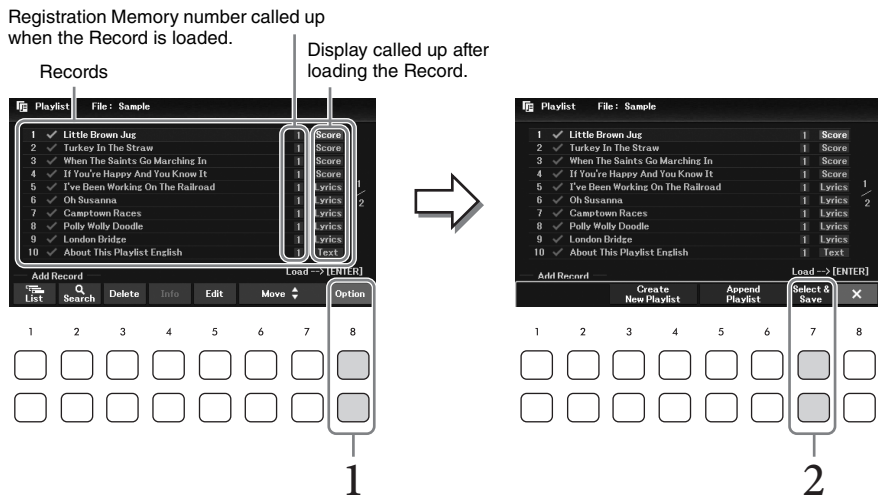

- 2 Use the [7▲▼] (*Select & Save*) buttons to call up the Playlist File Selection display.
- 3 Select the desired Playlist file.
- 4 Press the [EXIT] button to return to the *Playlist* display.
- 5 Select the Record on the Playlist display by using the Cursor buttons [▲][▼], and then press the [ENTER] button.

The Registration Memory Bank registered as the Playlist Record is recalled and the Action you've made (page 85) is executed.

NOTE

You can call up the Registration Bank Information window (page 83) by using the [4▲▼] (*Info*) buttons.

Changing the Order of the Records in the Playlist

- 1 On the Playlist display, move the cursor to the desired Record for moving by using the Cursor buttons [▲][▼].
- 2 Press the [6▲]/[7▲] (*Move*) button to move the Record upward in the list, or the [6▼]/[7▼] (*Move*) button to move the Record downward.
- 3 Save the edited Playlist file (step 5 on page 86).

Deleting the Record from the Playlist

- 1 On the Playlist display, move the cursor to the desired Record to delete by using the Cursor buttons [▲][▼].
- 2 Use the [3▲▼] (*Delete*) buttons to delete the selected Record.
A confirmation message appears. If you want to cancel the operation, press one of the [6▲▼] (*No*) buttons here.
- 3 Use the [7▲▼] (*Yes*) buttons to actually delete the Record.
- 4 Save the edited Playlist file (step 5 on page 86).

Advanced Features

Refer to the Reference Manual on the website, Chapter 7.



Copying the Playlist Records from another Playlist (Append Playlist): [PLAYLIST] → [8▲▼] (*Option*) → [5▲▼]/[6▲▼] (*Append Playlist*)

8 Mixer

- Editing the Volume and Tonal Balance -

The Mixer gives you intuitive control over aspects of the keyboard parts and Song/Style channels, including volume balance and the timbre of the sounds. It lets you adjust the levels and stereo position (pan) of each Voice to set the optimum balance and stereo image, and lets you set how the effects are applied.

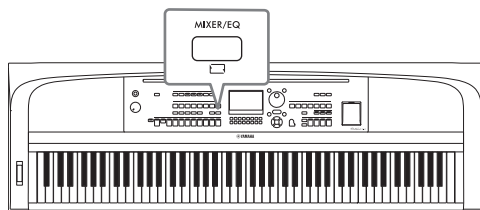

Basic Procedure

- 1 Press the [MIXER/EQ] button to call up the *Mixer* display.
- 2 Press the [MIXER/EQ] button repeatedly to select the parts for editing.

Pressing the [MIXER/EQ] button repeatedly selects the part to be edited.

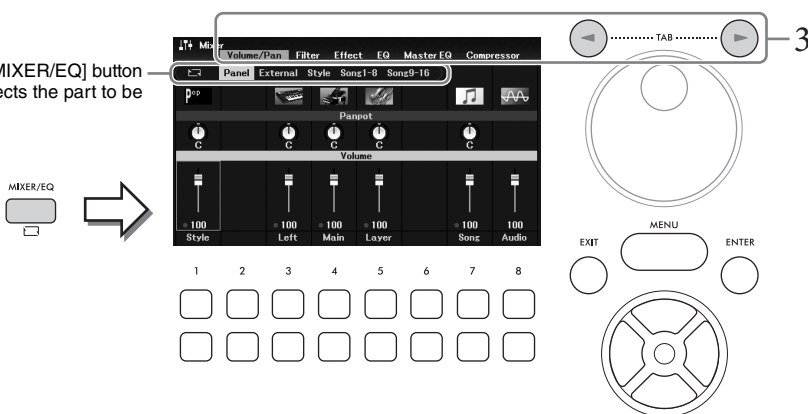

Panel	Select this when you want to adjust the balance among the Main part, Layer part, Left part, entire Song part, entire Style part, and Audio playback via the USB Audio Player function.
External	Select this when you want to adjust the balance among the microphone sound and Audio Input Sounds (page 95).
Style	Select this when you want to adjust the balance among the parts of the Style. <ul style="list-style-type: none"> • Rhy1, Rhy2: These are the basic parts of the Style, containing the drum and percussion rhythm patterns. • Bass: The bass part uses various appropriate instrument sounds to match the Style. • Chd1, Chd2: These comprise the rhythmic chord backing, commonly consisting of piano or guitar Voices. • Pad: This part is used for sustained instruments such as strings, organ, choir, etc. • Phr1, Phr2: These parts are used for punchy brass stabs, arpeggiated chords, and other extras that make the accompaniment more interesting.

<i>Song1-8, Song9-16</i>	Select this when you want to adjust the balance among all the parts (channels) of the Song.
------------------------------	---

3 Use the TAB [◀][▶] buttons to select the page for the parameters to be edited.

<i>Volume/Pan</i>	For adjusting volume and panning for each part and changing the Voice.
<i>Filter</i>	For adjusting the Harmonic Content (resonance) and sound brightness for each part.
<i>Effect</i>	For selecting an effect type and adjusting its depth for each part.
<i>EQ</i>	For adjusting equalization parameters to correct the tone or timbre of the sound for each part.

Unlike the other pages, select the following pages when you want to adjust the tonal characteristics of the entire sound (except for audio received via the USB Audio Player function and Audio Input Sounds) of this instrument.

<i>Master EQ</i>	For selecting the Master EQ (Equalizer) type applied to the entire sound. The related parameters can be edited and saved as your original Master EQ type.
<i>Compressor</i>	For turning the Master Compressor on/off and selecting its type. The related parameters can be edited and saved as your original Master Compressor type.

For details, refer to the Reference Manual on the website.

4 Use the Cursor buttons [▲][▼][◀][▶] to select a parameter, and then use the [1▲▼] - [8▲▼] buttons to set the value for each part.

5 Save your Mixer settings.

■ To save the *Panel* settings:

Register them to Registration Memory (page 81).

■ To save the *External* settings:

For the microphone settings, register them to Registration Memory (page 81).

For the Audio Input Sounds, the save operation is not necessary. These settings are retained even when the power is turned off.

■ To save the *Style* settings:

Save them as a Style file to the User drive or USB flash drive. If you want to recall the settings for future use, select the Style file saved here.

1. Call up the operation display.

[MENU] → Cursor buttons [▲][▼][◀][▶] *Style Creator*, [ENTER]

2. After the message asking whether you want to edit the existing Style or create a new Style appears, press one of the [5▲▼]/[6▲▼] (*Current Style*) buttons.

3. Press the [EXIT] button to close the *Rec Channel* window.

4. Press one of the [8▲▼] (*Save*) buttons to call up the Style Selection display, and then save the settings as a Style file (page 26).

■ **To save the *Song* settings:**

First register the edited settings as part of the Song data (Setup data), and then save the Song to the User drive or USB flash drive. If you want to recall the settings for future use, select the Song file saved here.

1. Call up the operation display.

[MENU] → Cursor buttons [▲][▼][◀][▶] *Song Creator*, [ENTER]

2. Use the TAB [◀][▶] buttons to select the *Setup* tab.

3. Use the Cursor buttons [▲][▼][◀][▶] to select the item to be saved, and then press the [ENTER] button to enter (or remove) the corresponding checkmark.

4. Use the [6 ▲▼]/[7 ▲▼] (*Apply*) buttons to actually apply the changes.

5. Press one of the [8▲▼] (*Save*) buttons to call up the Song Selection display, and then save the settings as a Song file (page 26).

Advanced Features

Refer to the Reference Manual on the website, Chapter 8.



9 Connections

– Using Your Instrument with Other Devices –

CAUTION

Before connecting the instrument to other electronic components, turn off the power of all the components. Also, before turning any components on or off, make sure to set all volume levels to minimum (0). Otherwise, damage to the components, electrical shock, or even permanent hearing loss may occur.

NOTICE

Do not place any external devices in an unstable position. Doing so may cause the device to fall and result in damage.

Connecting USB Devices ([USB TO DEVICE] terminal)

You can connect a USB flash drive or a USB wireless LAN adaptor to the [USB TO DEVICE] terminal. You can save data you've created on the instrument to the USB flash drive (page 26), or you can connect the instrument to a smart device via USB wireless LAN adaptor (page 94).

Precautions when using the [USB TO DEVICE] terminal

This instrument features a built-in [USB TO DEVICE] terminal. When connecting a USB device to the terminal, be sure to handle the USB device with care. Follow the important precautions below.

NOTE

For more information about the handling of USB devices, refer to the owner's manual of the USB device.

Compatible USB devices

- USB flash drive
- USB wireless LAN adaptor (UD-WL01; sold separately)

Other USB devices such as a USB hub, computer keyboard or mouse cannot be used.

The instrument does not necessarily support all commercially available USB devices. Yamaha cannot guarantee operation of USB devices that you purchase. Before purchasing a USB device for use with this instrument, please visit the following web page to check the "Compatible USB Device List":

<https://download.yamaha.com/>

Although USB devices 2.0 to 3.0 can be used on this instrument, the amount of time for saving to or loading from the USB device may differ depending on the type of data or the status of the instrument. USB devices 1.1 cannot be used on this instrument.

NOTICE

The rating of the [USB TO DEVICE] terminal is a maximum of 5V/500mA. Do not connect USB devices having a rating above this, since this can cause damage to the instrument itself.

Connecting a USB device

When connecting a USB device to the [USB TO DEVICE] terminal, make sure that the connector on the device is appropriate and that it is connected in the proper direction.

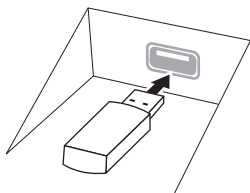

NOTICE

- Avoid connecting or disconnecting the USB device during playback/recording and file management operations (such as Save, Copy, Delete and Format), or when accessing the USB device. Failure to observe this may result in "freezing" of the operation of the instrument or corruption of the USB device and the data.
- When connecting then disconnecting the USB device (and vice versa), make sure to wait a few seconds between the two operations.
- Do not use an extension cable when connecting a USB device.

Using USB flash drives

By connecting the instrument to a USB flash drive, you can save data you've created to the connected device, as well as read data from the connected USB flash drive.

Maximum number of USB flash drives

Only one USB flash drive can be connected to the [USB TO DEVICE] terminal.

Formatting USB flash drives

You should format the USB flash drive only with this instrument (page 92). A USB flash drive formatted on another device may not operate properly.

NOTICE

The format operation overwrites any previously existing data. Make sure that the USB flash drive you are formatting does not contain important data.

To protect your data (write-protect)

To prevent important data from being inadvertently erased, apply the write-protect provided with each USB flash drive. If you are saving data to the USB flash drive, make sure to disable write-protect.

Turning off the instrument

When turning off the instrument, make sure that the instrument is NOT accessing the USB flash drive by playback/recording or file management (such as during Save, Copy, Delete and Format operations). Failure to do so may corrupt the USB flash drive and the data.

Formatting a USB Flash Drive

When a USB flash drive is connected, a message may appear indicating that the connected USB flash drive is not formatted. If so, execute the format operation.

NOTICE

The Format operation deletes any previously existing data. Make sure that the USB flash drive you are formatting does not contain important data.

- 1 Connect a USB flash drive for formatting to the [USB TO DEVICE] terminal.
- 2 Call up the operation display.
[MENU] → Cursor buttons [▲][▼][◀][▶] *Utility*, [ENTER] → TAB [◀][▶] *USB*

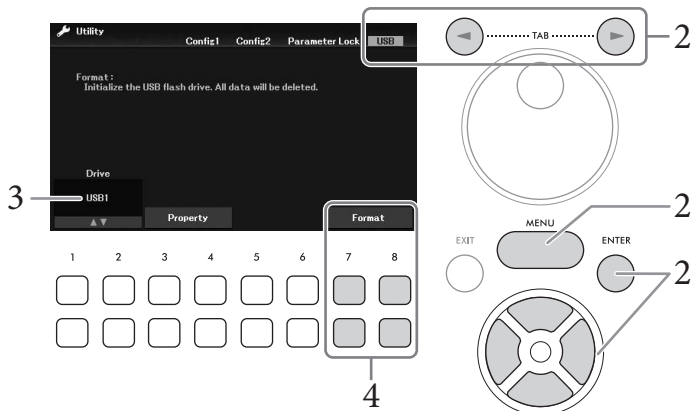

- 3 Make sure that *USB1* is shown as an available drive.
- 4 Use the [7▼▲]/[8▼▲] (*Format*) buttons to format the USB flash drive.
Press one of the [7▼▲] (*Yes*) buttons to actually execute the Format operation.

Confirming the remaining memory

You can check the remaining memory of the connected USB flash drive by using the [3▼▲]/[4▼▲] (*Property*) buttons in step 3 above.

Connecting to a Computer ([USB TO HOST] terminal)

By connecting a computer to the [USB TO HOST] terminal, you can transfer MIDI data or Audio data between the instrument and the computer. For details on using a computer with this instrument, refer to the “Computer-related Operations” on the website.

NOTICE

- Use an AB type USB cable of less than 3 meters. USB 3.0 cables cannot be used.
- If you are using a DAW (digital audio workstation) application with this instrument, set the Audio Loopback function (page 93) to off. Otherwise, a loud sound may occur, depending on the settings of the computer or the application software.

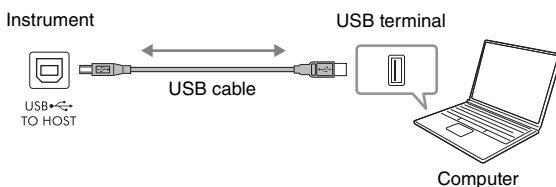

NOTE

- When using a USB cable to connect the instrument to your computer, make the connection directly without passing through a USB hub.
- The instrument will begin transmission a short time after the USB connection is made.

Transmitting/Receiving Audio Data (USB Audio Interface function)

By connecting a computer or a smart device to the [USB TO HOST] terminal via a USB cable, digital audio data can be transmitted/received. This USB Audio Interface function provides the following advantages:

■ **Playing back audio data with high sound quality**

This gives you direct, clear sound in which the sound quality has less noise and deterioration than that from the [AUX IN] jack

■ **Recording your performance on the instrument as audio data by using recording software or music production software**

The recorded audio data can be played back on the computer or smart device.

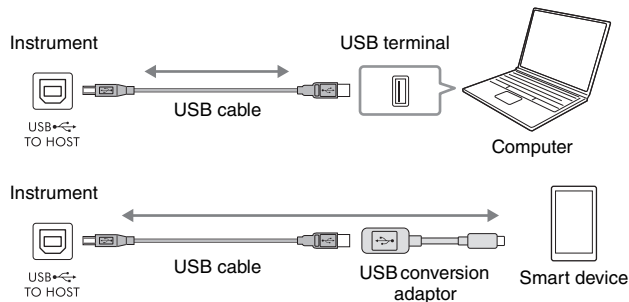

NOTE

- When transmitting or receiving audio signals by using a computer running Windows, the Yamaha Steinberg USB Driver should be installed to the computer. For details, refer to the "Computer-related Operations" on the website.
- For instructions on connecting to a smart device, refer to the "Smart Device Connection Manual" on the website.

Turning Audio Loopback On/Off

This allows you to set whether Audio Input Sound (page 95) from the external device is output to a computer or a smart device or not along with the performance played on the instrument. To output the Audio Input Sound, set the Audio Loopback to on.

For example, if you want to record the Audio Input Sound as well as the sound played on the instrument by using the connected computer or smart device, set this to on. If you intend to record only the sound played on the instrument by using the computer or smart device, set this to off.

The setting can be made via [MENU] → Cursor buttons [▲][▼][◀][▶] *Utility*, [ENTER] → TAB [◀]

Config1 → Cursor buttons [▲][▼] **2 Audio Loopback.**

NOTE

- When recording by using the USB Audio Recorder function (page 75), the Audio Input Sound from the external device is recorded when this is set to *On*, and not recorded when set to *Off*.
- The sound cannot be output to a device connected by the [AUX IN] jack or Bluetooth.

Connecting to a Smart Device ([AUX IN] jack/Bluetooth/[USB TO HOST] terminal/Wireless LAN)

Connecting a smart device such as a smart phone or tablet provides the following advantages:

- By connecting via the [AUX IN] jack (page 95) or Bluetooth (page 96), you can hear the sound output from the smart device through the built-in speakers of the instrument.
- By connecting via the [USB TO HOST] terminal, you can transmit/receive audio data (USB Audio Interface function; page 93).
- By connecting via a USB wireless LAN adaptor (UD-WL01; sold separately) or USB cable, you can use compatible smart device apps.

For instructions on connection by using a method other than via [AUX IN] jack or Bluetooth, refer to the “Smart Device Connection Manual” on the website.

NOTICE

- Use an AB type USB cable of less than 3 meters. USB 3.0 cables cannot be used.
- Do not connect this product to public Wi-Fi and/or Internet directly. Only connect this product to the Internet through a router with strong password-protections. Consult your router manufacturer for information on security best practices.

Example

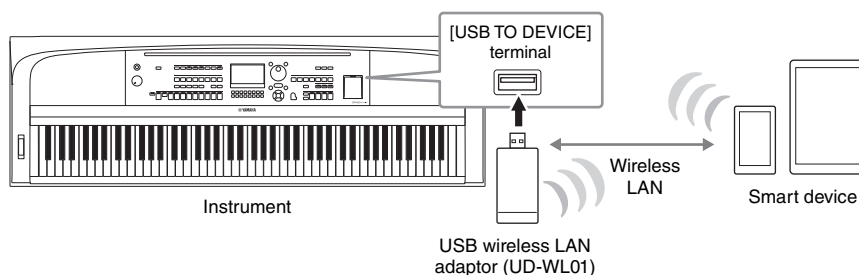

NOTE

- The USB wireless LAN adaptor (UD-WL01) may not be available depending on your area.
- Before using the [USB TO DEVICE] terminal, be sure to read “Precautions when using the [USB TO DEVICE] terminal” on page 91.
- When using a USB cable to connect the instrument to your smart device, make the connection directly without passing through a USB hub.
- The instrument will begin transmission a short time after the smart device is connected.
- When you use your smart device near the instrument, we recommend that you set Wi-Fi or Bluetooth to on after enabling “Airplane Mode” on that device in order to avoid noise caused by communication.
- You can set whether Audio Sound Input from the external device is output to a computer or smart device or not along with the performance played on the instrument. For details, refer to page 93.

Using a Smart Device App

By connecting to a smart device and using the compatible smart device app, you can get more enjoyment out of this instrument. For information about the compatible apps and smart devices, access the web page of the respective apps on the following page:

<https://www.yamaha.com/kbdapps/>

Listening to Audio Playback by an External Device through the Instrument's Speaker ([AUX IN] jack/Bluetooth/[USB TO HOST] terminal)

Audio playback by the connected device can be output from the instrument's speaker. To input audio, connect an external device by one of the following methods.

- Connecting to the [AUX IN] jack by using an audio cable
- Connecting by Bluetooth (Bluetooth Audio function; page 96)
- Connecting to the [USB TO HOST] terminal by using a USB cable (USB Audio Interface function; page 93)

When connecting to a smart device, you can also connect by using a USB wireless LAN adaptor (UD-WL01; sold separately). For information about connection with a smart device, refer to page 94.

Audio Input Sound:

In this manual, "Audio Input Sound" refers to audio input to the instrument from the external devices connected by these methods.

NOTE

- The volume of the Audio Input Sound can be adjusted from the external device.
- You can adjust the volume balance among the sounds of the instrument and the Audio Sound Input in the *Mixer* display (page 88).
- You can set whether Audio Input Sound from the external device is output to a computer or a smart device or not along with the performance played on the instrument. For details, refer to page 93.

Connecting to an Audio Player by using an Audio Cable ([AUX IN] jack)

You can connect the headphone jack of an audio player such as a smartphone and portable audio player to the instrument's [AUX IN] jack. Audio playback on the connected device is output from the built-in speakers of this instrument.

NOTICE

To avoid damage to the devices, first turn on the power to the external device, and then to the instrument. When turning off the power, first turn off the power to the instrument, and then to the external device.

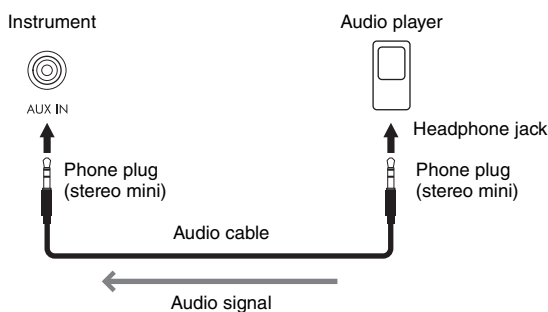

NOTE

Use audio cables and adaptor plugs having no (zero) resistance.

Minimizing noise of the input sound via Noise Gate

By default, this instrument cuts unwanted noise from the input sound. However, this may result in wanted sounds also being cut, such as the soft decay sound of a piano or acoustic guitar. To avoid this, set the Noise Gate to off via [MENU] → Cursor buttons [▲][▼][◀][▶] *Utility*, [ENTER] → TAB [◀] *Config1* → Cursor buttons [▲][▼] *2 AUX In Noise Gate*.

Listening to Audio data from a Bluetooth-equipped device through this instrument (Bluetooth Audio Function)

Before using the Bluetooth function, be sure to read “About Bluetooth” on page 97.

You can play the sound of audio data saved in a Bluetooth-equipped device, such as a smartphone or portable audio player, on this instrument and listen to it through the built-in speaker of the instrument.

Bluetooth-equipped device:

In this manual, “Bluetooth-equipped device” refers to a device that can transmit audio data saved in it to the instrument using the Bluetooth function, via wireless communication. For proper operation, the device must be compatible with A2DP (Advanced Audio Distribution Profile). The Bluetooth Audio function is explained here by using a smart device as an example of such Bluetooth-equipped devices.

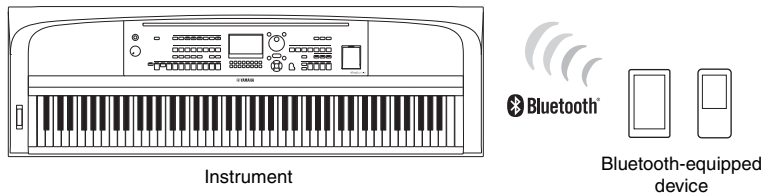

Bluetooth capability

Depending on the country in which you purchased the product, the instrument may not have Bluetooth capability. If the Bluetooth logo is printed on the [MENU] button, this means that the product is equipped with Bluetooth functionality.

A close-up of the 'MENU' button on the instrument's control panel. A small Bluetooth logo is printed on the right side of the button. Labels 'EXIT', 'MENU', and 'ENTER' are positioned around the button. A line points from the text 'Bluetooth logo' to the logo on the button.

1 Call up the *Bluetooth* display.

[MENU] → Cursor buttons [▲][▼][◀][▶] *Bluetooth*, [ENTER]

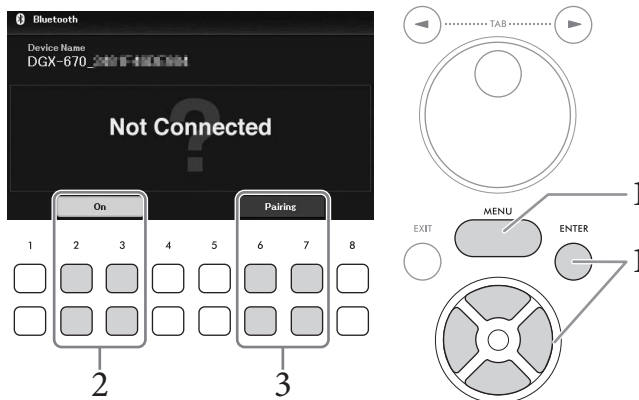

2 Make sure that the Bluetooth function is set to *On*.

You can turn the Bluetooth function on/off by using the [2▲▼]/[3▲▼] buttons.

3 Use the [6▲▼]/[7▲▼] (*Pairing*) buttons to pair with a Bluetooth-equipped device.

If you wish to connect your Bluetooth-equipped device to the instrument, the device needs to be paired with the instrument first. Once the device has been paired with this instrument, there is no need to perform pairing again.

You can also start pairing simply by holding down the [MENU] button for 3 seconds (with no need to call up the Bluetooth display).

NOTE

- “Pairing” means to register Bluetooth-equipped devices on this instrument, and establish the mutual recognition for wireless communication between the two.
- Only one smart device can be connected to this instrument at a time (although up to 8 smart devices can be paired to this instrument). When pairing with the 9th smart device has succeeded, pairing data for the device with the oldest connection date will be deleted.
- Bluetooth headphones or speakers cannot be paired.

4 On the Bluetooth-equipped device, set the Bluetooth function to on and select the device name containing “DGX-670” from the connection list.

After pairing is completed, the name of the Bluetooth-equipped device and “*Connected*” are shown in the display.

NOTE

If you are required to enter a passkey, enter the numerals “0000.”

5 Play back audio data on the smart device to confirm that the built-in speakers of the instrument can output the audio sound.

When you turn on the instrument the next time, the last-connected Bluetooth-equipped device will be connected to this instrument automatically, if the Bluetooth function of the Bluetooth-equipped device and the instrument is set to on. If it is not connected automatically, select the model name of the instrument from the connection list on the Bluetooth-equipped device.

About Bluetooth

Bluetooth is a technology for wireless communication between devices within an area of about 10 meters (33 ft.) employing the 2.4 GHz frequency band.

■ Handling Bluetooth communications

The 2.4 GHz band used by Bluetooth compatible devices is a radio band shared by many types of equipment. While Bluetooth compatible devices use a technology minimizing the influence of other components using the same radio band, such influence may reduce the speed or distance of communications and in some cases interrupt communications.

- The speed of signal transfer and the distance at which communication is possible differs according to the distance between the communicating devices, the presence of obstacles, radio wave conditions and the type of equipment.
- Yamaha does not guarantee all wireless connections between this unit and devices compatible with Bluetooth function.

Connecting Headphones or an External Speaker ([PHONES/OUTPUT] jack)

The [PHONES/OUTPUT] jack can be used to connect headphones, as well as for sending the output signal to the connected device, such as a speaker, recorder or computer. The speakers of this instrument are automatically shut off when a plug is inserted into this jack.

CAUTION

Do not use the instrument/device or headphones for a long period of time at a high or uncomfortable volume level, since this can cause permanent hearing loss.

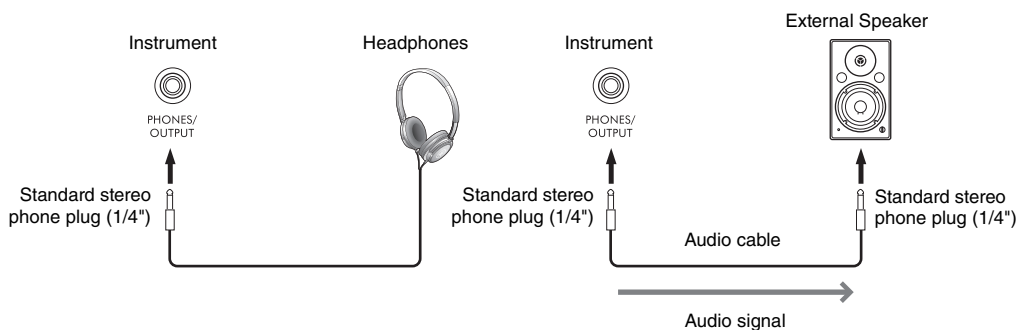

NOTICE

- To avoid possible damage, first turn on the power to the instrument, and then to the external device. When turning off the power, first turn off the power to the external device, and then to the instrument. Since this instrument's power may automatically be turned off due to the Auto Power Off function (page 17), turn off the power to the external device, or disable Auto Power Off when you do not intend to operate the instrument.
- Do not route the output from the [PHONES/OUTPUT] jack to the [AUX IN] jack. If you make this connection, the signal input at the [AUX IN] jack is output from the [PHONES/OUTPUT] jack. These connections could result in a feedback loop that will make normal performance impossible, and may even damage the equipment.

NOTE

Use audio cables and adaptor plugs having no (zero) resistance.

Reproducing a Natural Sound Distance Sensation (even when using Headphones)— Stereophonic Optimizer

The Stereophonic Optimizer feature recreates for headphones the spacious sensation you hear when you play an acoustic piano. In general, the sound from headphones is much too close to your ears for natural sound. When this function is turned on, you can sense a natural sound distance as if the sound is coming from the piano, even though you hear it on headphones. This function is effective only on the VRM Voices (page 41) and does not affect the sound output of the instrument speakers. The default setting of this function is on. You can turn it on or off via [MENU] → Cursor buttons [▲][▼][◀][▶] *Utility*, [ENTER] → TAB [◀] *Config1* → Cursor button [▼] **3 Stereophonic Optimizer**. For details, refer to the Reference Manual on the website, Chapter 10.

Connecting a Microphone ([MIC INPUT] jack)

To the [MIC INPUT] jack (standard phone jack), you can connect a microphone to enjoy singing along with your keyboard performance or with Song/Audio playback. For instructions, refer to page 77.

Connecting a Foot Pedal ([AUX PEDAL] jack)

The included footswitch or other separately sold foot pedals (FC3A, FC4A or FC5) can be connected to the [AUX PEDAL] jack. For details, refer to page 14.

NOTE

- Make sure that power is off when connecting or disconnecting the pedal.
- Do not press the footswitch while turning the power on. Doing this changes the recognized polarity of the pedal, resulting in reversed operation.

Connecting a Pedal Unit ([PEDAL UNIT] jack)

The separately sold LP-1B or LP-1WH pedal unit can be connected to the [PEDAL UNIT] jack. For details, refer to page 15.

NOTE

- Make sure that power is off when connecting or disconnecting the pedal.
- Do not press the pedals while turning the power on. Doing this changes the recognized polarity of the pedals, resulting in reversed operation.

Advanced Features

Refer to the Reference Manual on the website, Chapter 9.



Assigning specific functions to each pedal:	[MENU] → Cursor buttons [▲][▼][◀][▶] <i>Controller</i> , [ENTER] → TAB [◀] <i>Pedal</i>
Making MIDI related settings:	[MENU] → Cursor buttons [▲][▼][◀][▶] <i>MIDI</i> , [ENTER]
Making wireless LAN settings:	[MENU] → Cursor buttons [▲][▼][◀][▶] <i>Wireless LAN</i> , [ENTER]

10 Menu

– Making Global Settings and Using Advanced Features –

The Menu provides a variety of convenient settings and tools for the instrument. These include general settings that affect the entire instrument, as well as detailed settings for specific functions. Also included are advanced Creator features, such as for creating your own Styles and Songs.

Basic Procedure

This section covers only how to call up the operation display for each function. For information on what you can do with each function, or where you can find detailed instructions, refer to the Function List on Page 101.

- 1 Press the [MENU] button to call up the Menu display.

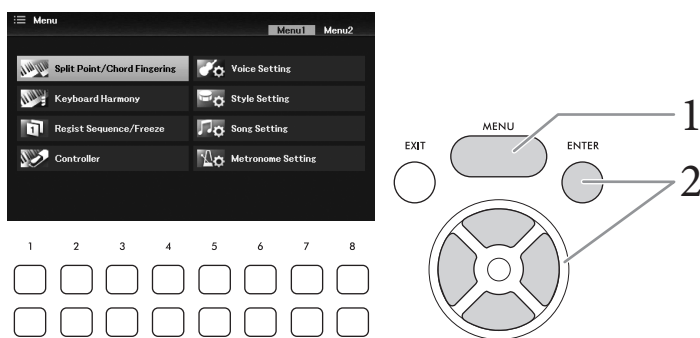

- 2 Move the cursor to the desired function by using the Cursor buttons [▲][▼][◀][▶], and then press the [ENTER] button to call up the corresponding display.

The *Menu* display consists of two pages (*Menu1/Menu2*). You can switch between these pages by using the TAB [◀][▶] buttons, although the Cursor buttons [▲][▼][◀][▶] can also be used.

- 3 If the display consists of multiple pages (tabs), use the TAB [◀][▶] buttons to select the desired page.

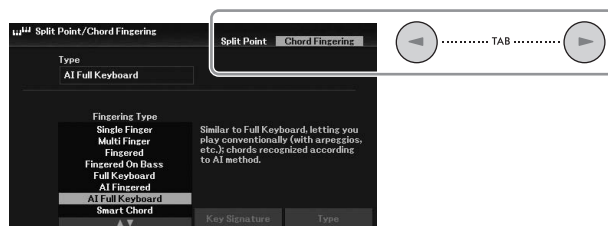

- 4 Make the desired settings or operations on the relevant page.

Function List

This list briefly explains what you can do in the displays which are called up via the [MENU] button. For more information, refer to the page and chapter references indicated below.

Menu1	Description		Owner's Manual	Reference Manual
Split Point/ Chord Fingering	Split Point	Determines the Split Point and Chord Detection Area.	Page 58	Chapter 3
	Chord Fingering	Determines the Chord Fingering type.	Page 56	Chapter 3
Keyboard Harmony	For selecting the Keyboard Harmony type and making related settings. This display can also be called up via [VOICE EFFECT] → Cursor button [▼] 2 Keyboard Harmony → [4▲▼] (Type).		Page 46	Chapter 2
Regist Sequence/ Freeze	Registration Sequence	Determines the order for calling up Registration Memory settings when using the TAB [◀][▶] buttons or the footswitch (pedal).	–	Chapter 7
	Freeze	Determines the setting groups (Voice, Style, etc.) that are to remain unchanged even when you call up panel setups via Registration Memory.	–	Chapter 7
Controller	Pedal	Determines the functions assigned to the pedals.	–	Chapter 9
	Setting	For setting the Touch Response of the keyboard, pitch bend range, etc.	Pages 43, 45	Chapter 9
Voice Setting	Piano	For turning the VRM effect on/off, or adjusting the Reverb/Chorus depth and other settings for piano Voices.	Page 41	Chapter 2
	Tune	For adjusting the pitch for each keyboard part (Main/Layer/Left).	–	Chapter 2
	Voice Set Filter	Determines which settings (effects, etc.) linked to the Voices are not called up when selecting a Voice.	–	Chapter 2
Style Setting	Setting1, 2	For making Style playback related settings such as Unison & Accent, Auto Fill-in, Intro/Ending type, Synchro Stop, Stop ACMP, etc.	Page 54	Chapter 3
	Adaptive Style	For turning the Adaptive Style function on/off and making related settings.	Page 51	–
Song Setting	Play	For making Song playback related settings such as repeat mode, fast forward type, Quick Start, etc.	Page 67	Chapter 4
	Setting	For making general settings for Songs such as Guide mode, and channel assignments for the Right and Left parts.	Page 66	Chapter 4
Metronome Setting	Determines the metronome volume, sound and time signature. The sound type or volume of the sound caused when tapping the [TEMPO/TAP] button can also be set.		–	Chapter 2

Menu2	Description		Owner's Manual	Reference Manual
Style Creator	For creating a Style by editing the preset Style, or by recording Style channels one by one.		–	Chapter 3
Song Creator	For creating a Song by editing the recorded Song or by re-recording a specific section.		–	Chapter 4
Chord Tutor	Displays an example of how to play a chord that corresponds to the specified chord name.		–	Chapter 3
Master Tune/ Scale Tune	Master Tune	For fine-tuning the pitch of the entire instrument in approx. 0.2 Hz steps.	Page 45	Chapter 2
	Scale Tune	For selecting the scale type and tuning the pitch of the desired note (key) in cents.	Page 45	Chapter 2
Bluetooth ^{*1}	For connecting to a Bluetooth-equipped device.		Page 96	–
MIDI	For making MIDI-related settings.		–	Chapter 9

<i>Menu2</i>	Description		Owner's Manual	Reference Manual
Utility	Config 1, 2	For making general settings such as speaker output, AUX In Noise Gate, Audio Loopback, Stereophonic Optimizer, and IAC, etc.	Pages 17, 93, 95, 98	Chapter 10
	Parameter Lock	Determines the parameters (effect, Split Point, etc.) that are to remain unchanged when the panel setups are changed via Registration Memory, One Touch Setting, etc.	–	Chapter 10
	USB	Indicates the capacity of the connected USB flash drive, and allows you to format it.	Page 92	–
System	Common	Indicates the firmware version of this instrument, and lets you make basic settings, such as the language for the display and the Auto Power Off function.	Page 18	–
	Backup/Restore	For backing up and restoring the settings and data saved in the User drive of the instrument.	Page 33	–
	Setup Files	For saving and recalling the specified settings of the instrument.	–	Chapter 10
	Reset	For restoring the instrument settings to their factory defaults.	–	Chapter 10
Wireless LAN *2	For making settings for connecting the instrument to a smart device, such as a smartphone or tablet, via a USB wireless LAN adaptor.		–	Chapter 9

*1 This function appears on the Menu display only if the instrument is equipped with Bluetooth functionality. Depending on the country in which you purchased it, Bluetooth may not be available.

*2 This function appears on the Menu display only when the USB wireless LAN adaptor (UD-WL01; sold separately) has been connected once.

Troubleshooting

Overall	
A click or pop is heard when the power is turned on or off.	This is normal. Electrical current is being applied to the instrument.
The power is automatically turned off.	This is normal and due to the Auto Power Off function. If necessary, set the parameter of the Auto Power Off function (page 18).
Noise is heard from the instrument's speakers.	Noise may be heard if a mobile phone is used near the instrument or if the phone is ringing. Turn off the mobile phone, or use it further away from the instrument.
Noise is heard from the instrument's speakers or headphones when using the instrument with the app on the smart device such as smartphone or tablet.	When you use the instrument along with the app on your smart device, we recommend that you set Wi-Fi or Bluetooth to on after enabling "Airplane Mode" on that device in order to avoid noise caused by communication.
In the LCD, there are some specific points that are always lit or unlit.	These are the result of defective pixels and occasionally occur in TFT-LCDs; they do not indicate a problem in operation.
Mechanical noise is heard during performance.	The keyboard mechanism of this instrument simulates the keyboard mechanism of an actual piano. Mechanical noise is also heard on a piano.
There is a slight difference in sound quality among different notes played on the keyboard.	This is normal and is a result of the instrument's sampling system.
Some Voices have a looping sound.	
Some noise or vibrato is noticeable at higher pitches, depending upon the Voice.	
The overall volume is too low or no sound is heard.	<ul style="list-style-type: none"> • The master volume may be set too low. Set it to an appropriate level with the [MASTER VOLUME] dial. • All keyboard parts are set to off. Use the PART ON/OFF [MAIN]/[LAYER]/[LEFT] button to turn on the desired part. • The volume of the individual parts may be set too low. Raise the volume in the <i>Mixer</i> display (page 88). • Make sure the desired channel is set to on (pages 53, 65). • Make sure a pair of headphones or an adapter plug is not connected to the [PHONES/OUTPUT] jack. • Make sure that the Speaker setting is set to <i>On</i>: [MENU] → Cursor buttons [▲][▼][◀][▶] <i>Utility</i>, [ENTER] → TAB [◀] <i>Config 1</i> → Cursor button [▲] <i>1 Speaker</i>. For details, refer to the Reference Manual on the website, Chapter 10.
The sound is distorted or noisy.	<ul style="list-style-type: none"> • The volume may be turned up too high. Make sure all relevant volume settings are appropriate. • This may be caused by certain effects or filter settings. Check the effect or filter settings and change them accordingly in the <i>Mixer</i> display, referring to the Reference Manual on the website, Chapter 8.
Not all simultaneously played notes sound.	You are probably exceeding the maximum polyphony (page 106) of the instrument. When the maximum polyphony is exceeded, the earliest played notes will stop sounding, letting the latest played notes sound.
The keyboard volume is lower than the Song/Style playback volume.	The volume of the keyboard parts may be set too low. Raise the keyboard volume (Main/Layer/Left), or lower the Song/Style volume in the <i>Mixer</i> display (page 88).
The Main display does not appear even when turning the power on.	This may occur if a USB flash drive has been installed to the instrument. Installation of some USB flash drives may result a long interval between turning the power on and appearance of the Main display. To avoid this, turn the power on after disconnecting the device.
Some characters of the file/folder name are garbled.	The language settings have been changed. Set the appropriate language for the file/folder name (page 18).

Overall	
An existing file is not shown.	<ul style="list-style-type: none"> The file extension (.MID, etc.) may have been changed or deleted. Manually rename the file, adding the appropriate extension, on a computer. Data files with names of more than 50 characters cannot be handled by the instrument. Rename the file, reducing the number of characters to 50 or less.

Voice	
The Voice selected from the Voice Selection display does not sound.	Turn on the PART ON/OFF button for the desired part (page 38).
A strange “flanging” or “doubling” sound occurs. The sound is slightly different each time the keys are played.	The Main and Layer parts are turned on, and both parts are set to play the same Voice. Turn off the Layer part or change the Voice of one of the parts.
Some Voices will jump an octave in pitch when played in the upper or lower registers.	This is normal. Some Voices have a pitch limit which, when reached, causes this type of pitch shift.
No sound is heard or sound is strange in the left-hand section.	If the <i>Stop ACMP</i> parameter is set to something other than <i>Disabled</i> via [MENU] → Cursor buttons [▲][▼][◀][▶] <i>Style Setting</i> , [ENTER] → TAB [◀][▶] <i>Setting2</i> , the Voice on the chord section does not sound normally when the [ACMP] button is on. Set the <i>Stop ACMP</i> parameter to <i>Disabled</i> or turn the [ACMP] button off. For details about the Stop ACMP function, refer to the Reference Manual on the website, Chapter 3.

Style	
The Style does not start even when the [START/STOP] button is pressed.	The Rhythm channel of the selected Style may not contain any data. Turn the [ACMP] button on and play left-hand section on the keyboard to sound the accompaniment part of the Style.
Only the rhythm channel plays.	<ul style="list-style-type: none"> Make sure the Auto Accompaniment function is turned on; press the [ACMP] button. Make sure to play keys in the chord section of the keyboard (page 49).
Styles in a USB flash drive cannot be selected.	If the size of the Style data is large (about 120 KB or greater), the Style cannot be selected because the data is too large to be handled by the instrument.

Song	
Songs cannot be selected.	<ul style="list-style-type: none"> This may be because the language settings have been changed. Set the appropriate language for the Song file name (page 18). If the size of the Song data is large (about 300 KB or greater), the Song cannot be selected because the data is too large to be handled by the instrument.
Song playback stops before the Song is finished.	The Guide function is turned on. (In this case, playback is “waiting” for the correct key to be played.) Turn off the Guide function (page 65).
The measure number is different from that of the score in the Song Position display, shown by pressing the [◀◀] (Rewind)/[▶▶] (Fast forward) buttons.	This happens when playing back music data for which a specific, fixed tempo is set.
When playing back a Song, some channels do not play.	Playback of these channels may be set to off. Turn playback on for those channels that are set to off (page 65).
The tempo, beat, measure and music notation is not displayed correctly.	Some Song data for the instrument has been recorded with special “free tempo” settings. For such Song data, the tempo, beat, measure and music notation will not be displayed correctly.

USB Audio Player/Recorder	
A message indicating the drive is busy appears, and the recording is aborted.	<ul style="list-style-type: none"> • Make sure to use a compatible USB flash drive (page 91). • Make sure that the USB flash drive has enough memory (page 92). • If you are using a USB flash drive to which data has already been recorded, check first that no important data remains on the device, and then format it (page 92) and try recording again.
Audio files cannot be selected.	The file format may not be compatible with the instrument. The compatible format is only WAV. The DRM protected files cannot be played back.
Recorded file is played back at a different volume compared to when it was recorded.	The audio playback volume has been changed (page 74). Setting the volume value to 100 plays back the file at the same volume as when it was recorded.

Microphone	
The microphone input signal cannot be recorded.	The microphone input signal cannot be recorded as a Song (in MIDI format). Record by using USB Audio Recorder (page 75).

Mixer	
The sound seems strange or different than expected when changing a rhythm Voice (Drum kit, etc.) of the Style or Song from the Mixer.	When changing the rhythm/percussion Voices (drum kits, etc.) of the Style and Song, the detailed settings related to the drum voice are reset, and in some cases you may be unable to restore the original sound. You can restore the original sound by selecting the same Song or Style again.

Connection	
The speakers do not switch off when a pair of headphones is connected to the [PHONES/OUTPUT] jack.	The Speaker setting is <i>On</i> . Set the speaker setting to <i>Headphone Switch</i> via [MENU] → Cursor buttons [▲][▼][◀][▶] <i>Utility</i> , [ENTER] → TAB [◀] <i>Config 1</i> → Cursor button [▼] <i>1 Speaker</i> . For details, refer to the Reference Manual on the website, Chapter 10.
The on/off setting of the pedal connected to the [AUX PEDAL] jack is reversed.	Change the polarity settings: [MENU] → Cursor buttons [▲][▼][◀][▶] <i>Controller</i> , [ENTER] → TAB [▶] <i>Setting</i> → Cursor button [▼] <i>3 AUX Pedal Polarity</i> . For details, refer to the Reference Manual on the website, Chapter 9.
The Wireless LAN icon is not shown in the Menu display even though the USB wireless LAN adaptor is connected.	Disconnect the USB wireless LAN adaptor and connect it again.
The Bluetooth-equipped device cannot be paired with nor connected to the instrument.	<p>Check the Bluetooth function of the Bluetooth-equipped device is activated. To connect the Bluetooth-equipped device and the instrument, Bluetooth function of both devices need to be turned on.</p> <ul style="list-style-type: none"> • The Bluetooth-equipped device and the instrument need to be paired to connect each other via Bluetooth (page 96). • In case there is a device (microwave oven, wireless LAN device, etc.) that outputs signals in the 2.4 GHz frequency band nearby, move this instrument away from the device that is emitting radio-frequency signals.
Sound input to the [AUX IN] jack is interrupted.	The output volume of the external device connected to the [AUX IN] jack of this instrument is too low. Increase the output volume of the external device. The volume level reproduced via this instrument's speakers can be adjusted by using the [MASTER VOLUME] dial. The Noise Gate function may be cutting the soft sounds. If this happens, turn off the <i>AUX In Noise Gate</i> parameter (page 95).

Specifications

Product Name		Digital Piano	
Size/Weight	Dimensions (W × D × H)		1,397 mm × 445 mm × 151 mm (55" × 17-1/2" × 5-15/16")
	Weight		21.4 kg (47 lb, 3 oz)
Control Interface	Keyboard	Number of Keys	88
		Type	GHS (Graded Hammer Standard) keyboard with matte black keytops
		Touch Response	Hard2/Hard1/Medium/Soft1/Soft2
	Other Controllers	Pitch Bend Wheel	Yes
	Display	Type	TFT Color WQVGA LCD
		Size	4.3 inch (480 × 272 dots)
		Score/Lyrics/Text Display Function	Yes
		Language	English, German, French, Spanish, Italian
Panel	Language	English	
Voices	Tone Generation	Piano Sound	Yamaha CFX
	Piano Effect	VRM	Yes
		Key-off Samples	Yes
		Smooth Release	Yes
	Polyphony (max.)		256
	Preset	Number of Voices	601 Voices + 29 Drum/SFX Kits
		Featured Voices	9 VRM Voices, 49 Super Articulation Voices, 23 MegaVoices, 11 Natural! Voices, 26 Sweet! Voices, 53 Cool! Voices, 68 Live! Voices
	Compatibility (for Song playback)		XG, GS, GM, GM2
Other Features	Mono/Poly	Yes	
Effects	Types	Reverb	58 Preset + 30 User
		Chorus	106 Preset + 30 User
		DSP	295 Preset + 30 User
		Master Compressor	5 Preset + 30 User
		Master EQ	5 Preset + 30 User
		Part EQ	27 Parts
		Intelligent Acoustic Control (IAC)	Yes
		Stereophonic Optimizer	Yes
	Functions	Dual (Layer)	Yes
		Split	Yes
Styles	Preset	Number of Styles	263
		Featured Styles	215 Pro Styles, 19 Session Styles, 29 Pianist Styles
		Fingering	Single Finger, Fingered, Fingered On Bass, Multi Finger, AI Fingered, Full Keyboard, AI Full Keyboard, Smart Chord
		Style Control	INTRO, MAIN VARIATION × 4, BREAK, ENDING, SIMPLE
	Custom	Style Creator	Yes
	Other Features	One Touch Setting (OTS)	4 for each Style
		Adaptive Style	Yes (50 Styles)
		Unison & Accent	Yes (50 Styles)
Compatibility		Style File Format (SFF), Style File Format GE (SFF GE)	
Songs (MIDI)	Preset	Number of Preset Songs	100
	Recording	Number of Tracks	16
		Data Capacity	Approx. 1 MB/Song
		Song Creator	Yes
	Format	Playback	SMF (Format 0, Format 1), XF
		Recording	SMF (Format 0)

USB Audio Player/Recorder	Recording Time (max.)		80 minutes/Song
	Format	Playback	WAV (44.1 kHz, 16-bit, stereo)
		Recording	WAV (44.1 kHz, 16-bit, stereo)
	Time Stretch		Yes
	Pitch Shift		Yes
	Vocal Cancel		Yes
Functions	Piano Room		Yes
	Registration Memory	Number of Buttons	4
		Control	Registration Sequence, Freeze
	Playlist	Number of Records (max.)	500
	Lesson/Guide		Follow Lights, Any Key, Karao-Key, Your Tempo
	USB Audio Interface		44.1 kHz, 16-bit, stereo
	Overall Controls	Metronome	Yes
		Tempo Range	5 – 500, Tap Tempo
		Transpose	-12 – 0 – +12
		Tuning	414.8 – 440.0 – 466.8 Hz (approx. 0.2 Hz increments)
		Scale Type	9 Types
	Bluetooth (May not have this functionality depending on the country in which you purchased the product.)	Bluetooth version	4.1
		Supported profile	A2DP
		Compatible codec	SBC
		Wireless output	Bluetooth class 2
		Maximum communication distance	Approx. 10 m
Radio Frequency (Operational Frequency)		2,402 – 2,480 MHz	
Maximum output power (EIRP)		4 dBm	
Type of modulation		GFSK, $\pi/4$ DQPSK, 8DPSK	
Storage and Connectivity	Storage	Internal Memory	Approx. 20 MB
		External Drives	USB flash drive
	Connectivity	DC IN	16 V
		Headphones/Output	Standard stereo phone jack
		Microphone	Standard mono phone jack
		AUX IN	Stereo mini jack
		AUX PEDAL	Yes
		PEDAL UNIT	Yes
		USB TO DEVICE	Yes
		USB TO HOST	Yes
Sound System	Amplifiers	6 W × 2	
	Speakers	(12 cm + 5 cm) × 2	
Power Supply	AC Adaptor	PA-300C	
	Power Consumption	14.5 W (When using PA-300C AC adaptor)	
	Auto Power Off	Yes	
Included Accessories		Owner's Manual, Online Member Product Registration, AC adaptor* (PA-300C), Power cord*, Music rest, Footswitch *May not be included depending on your area. Check with your Yamaha dealer.	
Separately Sold Accessories (May not be available depending on your area.)		Keyboard stand (L-300B/L-300WH), Pedal unit (LP-1B/LP-1WH), AC adaptor (PA-300C), Headphones (HPH-150/HPH-100/HPH-50), Foot pedal (FC3A), Footswitch(FC4A/FC5), USB wireless LAN adaptor (UD-WL01), Wireless MIDI adaptor (UD-BT01)	

The contents of this manual apply to the latest specifications as of the publishing date. To obtain the latest manual, access the Yamaha website then download the manual file. Since specifications, equipment or separately sold accessories may not be the same in every locale, please check with your Yamaha dealer.

Compatible Format

■ GM2

“GM (General MIDI)” is one of the most common Voice allocation formats. “GM System Level 2” is a standard specification that enhances the original “GM” and improves Song data compatibility. It provides for increased polyphony, greater Voice selection, expanded Voice parameters, and integrated effect processing.

■ XG

XG is a major enhancement of the GM System Level 1 format, and was developed by Yamaha specifically to provide more Voices and variations, as well as greater expressive control over Voices and effects, and to ensure compatibility of data well into the future.

■ GS

GS was developed by the Roland Corporation. In the same way as Yamaha XG, GS is a major enhancement of the GM specifically to provide more Voices and Drum kits and their variations, as well as greater expressive control over Voices and effects.

■ XF

The Yamaha XF format enhances the SMF (Standard MIDI File) standard with greater functionality and open-ended expandability for the future. This instrument is capable of displaying lyrics when an XF file containing lyric data is played.

■ SFF GE (Guitar Edition)

“SFF (Style File Format)” is an original Style file format by Yamaha which uses a unique conversion system to provide high-quality automatic accompaniment based on a wide range of chord types. “SFF GE (Guitar Edition)” is an enhanced format of SFF, which features improved note transposition for guitar tracks.

Index

Numerics

[1▲▼] – [8▲▼] buttons20

A

A-B Repeat 67, 73
Accent 55
Accessories 7
Accompaniment 48
Adaptive Style 51
AI Fingered 57
AI Full Keyboard 57
Audio 72
Audio Input Sound 95
Audio Loopback 93
Auto Accompaniment 48
Auto Power Off 17, 18
AUX IN 95

B

Backup 33
Balance 52, 89
Bluetooth Audio 96
Break 52

C

Channel (Part) 53, 65
Character entry 31
Chord Detection Area 57
Chord Fingering type 56
Chord Tutor 59
Computer 92
Connection 91
Copy 29
Cursor buttons 19

D

Data dial 20
Delete 30
Demo 11
Direct Access 22
Drum Kit Tutor 40
DSP 46

E

Effect (Mic) 78
Effect (Mixer) 89
Effect (Voice) 45
Ending section 50
EQ 89

F

Factory Reset 34
Fast forward 62, 73

File 26
File Selection display 24
Fill-in 52
Filter 89
Fingered 56
Fingered On Bass 56
Fingering type 56
Folder 27
Footswitch 14
Format 92
Freeze 83
Full Keyboard 57

G

Guide 65

H

Half pedal 15
Headphones 98

I

IAC (Intelligent Acoustic Control) 17
Initialize (Factory Reset) 34
Intro section 50

K

Keyboard Harmony 46
Keyboard stand 15

L

Language 18
Layer part 38
Left Hold 46
Left part 38
Left Split Point 58
Lyrics 64

M

Main display 23
Main part 38
Main variation 51
Master Compressor 89
Master EQ 89
Menu 100
Metronome 44
Microphone 77
MIDI 60
Mixer 88
Move 29
Multi Finger 56
Music rest 14

N	
Name	28
Noise Gate	95
O	
One Touch Setting (OTS)	52
OTS Link	52
Owner Name	18
P	
Panel Setup (Panel Settings)	13
Pause	62
Pedal	14
Pedal unit	15
Piano Reset	41
Piano Room	35
Pitch	44
Pitch Bend Wheel	45
Pitch Shift	74
Play (Audio)	72
Play (Song)	61
Play (Style)	50
Playlist	80, 84
Power	16
R	
Record	84
Recording (Audio)	75
Recording (Piano Room)	37
Recording (Song)	68
Registration Memory	80, 81
Registration Sequence	83
Rename	28
Repeat	67, 74
Reset	34
Restore	33
Rewind	62, 73
S	
Save	26
Score	63
Single Finger	56
Smart Chord	57
Smart Device	94
Song (MIDI)	60
Song Creator	71
Speaker	98
Split Point	58
Stand	15
Stereophonic Optimizer	98
Stop (Audio)	73
Stop (Style)	50
Style	48
Style Creator	59
Style Split Point	58
Super Articulation Voice	42
Synchro Start (Song)	62
Synchro Start (Style)	50
T	
Talk	78
Tempo	52
Text	64
Time Stretch	74
Touch Response	43
Touch Sensitivity	43
Transpose	44
Tuning	45
U	
Unison & Accent	54
USB Audio Interface	93
USB Audio Player	72
USB Audio Recorder	75
USB flash drive	91
USB TO DEVICE	91
USB TO HOST	92
USB wireless LAN adaptor	94
V	
Version	18
Vocal Cancel	74
Voice	38
Voice Effect	45
Volume	17
Volume (Audio)	74
Volume (Mic)	78
Volume Balance	52, 89
VRM (Virtual Resonance Modeling)	41

Apache License 2.0

Copyright (c) 2009-2018 Arm Limited. All rights reserved.

SPDX-License-Identifier: Apache-2.0

Licensed under the Apache License, Version 2.0 (the License); you may not use this file except in compliance with the License. You may obtain a copy of the License at www.apache.org/licenses/LICENSE-2.0

Unless required by applicable law or agreed to in writing, software distributed under the License is distributed on an AS IS BASIS, WITHOUT WARRANTIES OR CONDITIONS OF ANY KIND, either express or implied. See the License for the specific language governing permissions and limitations under the License.

Modified BSD license

COPYRIGHT(c) 2016 STMicroelectronics

Redistribution and use in source and binary forms, with or without modification, are permitted provided that the following conditions are met:

1. Redistributions of source code must retain the above copyright notice, this list of conditions and the following disclaimer.
2. Redistributions in binary form must reproduce the above copyright notice, this list of conditions and the following disclaimer in the documentation and/or other materials provided with the distribution.
3. Neither the name of STMicroelectronics nor the names of its contributors may be used to endorse or promote products derived from this software without specific prior written permission.

THIS SOFTWARE IS PROVIDED BY THE COPYRIGHT HOLDERS AND CONTRIBUTORS "AS IS" AND ANY EXPRESS OR IMPLIED WARRANTIES, INCLUDING, BUT NOT LIMITED TO, THE IMPLIED WARRANTIES OF MERCHANTABILITY AND FITNESS FOR A PARTICULAR PURPOSE ARE DISCLAIMED. IN NO EVENT SHALL THE COPYRIGHT HOLDER OR CONTRIBUTORS BE LIABLE FOR ANY DIRECT, INDIRECT, INCIDENTAL, SPECIAL, EXEMPLARY, OR CONSEQUENTIAL DAMAGES (INCLUDING, BUT NOT LIMITED TO, PROCUREMENT OF SUBSTITUTE GOODS OR SERVICES; LOSS OF USE, DATA, OR PROFITS; OR BUSINESS INTERRUPTION) HOWEVER CAUSED AND ON ANY THEORY OF LIABILITY, WHETHER IN CONTRACT, STRICT LIABILITY, OR TORT (INCLUDING NEGLIGENCE OR OTHERWISE) ARISING IN ANY WAY OUT OF THE USE OF THIS SOFTWARE, EVEN IF ADVISED OF THE POSSIBILITY OF SUCH DAMAGE.

COPYRIGHT AND PERMISSION NOTICE (ICU 58 and later)

Copyright © 1991-2016 Unicode, Inc. All rights reserved.
Distributed under the Terms of Use in <http://www.unicode.org/copyright.html>

Permission is hereby granted, free of charge, to any person obtaining a copy of the Unicode data files and any associated documentation (the "Data Files") or Unicode software and any associated documentation (the "Software") to deal in the Data Files or Software without restriction, including without limitation the rights to use, copy, modify, merge, publish, distribute, and/or sell copies of the Data Files or Software, and to permit persons to whom the Data Files or Software are furnished to do so, provided that either (a) this copyright and permission notice appear with all copies of the Data Files or Software, or (b) this copyright and permission notice appear in associated Documentation.

THE DATA FILES AND SOFTWARE ARE PROVIDED "AS IS", WITHOUT WARRANTY OF ANY KIND, EXPRESS OR IMPLIED, INCLUDING BUT NOT LIMITED TO THE WARRANTIES OF MERCHANTABILITY, FITNESS FOR A PARTICULAR PURPOSE AND NONINFRINGEMENT OF THIRD PARTY RIGHTS. IN NO EVENT SHALL THE COPYRIGHT HOLDER OR HOLDERS INCLUDED IN THIS NOTICE BE LIABLE FOR ANY CLAIM, OR ANY SPECIAL INDIRECT OR CONSEQUENTIAL DAMAGES, OR ANY DAMAGES WHATSOEVER RESULTING FROM LOSS OF USE, DATA OR PROFITS, WHETHER IN AN ACTION OF CONTRACT, NEGLIGENCE OR OTHER TORTIOUS ACTION, ARISING OUT OF OR IN CONNECTION WITH THE USE OR PERFORMANCE OF THE DATA FILES OR SOFTWARE.

Except as contained in this notice, the name of a copyright holder shall not be used in advertising or otherwise to promote the sale, use or other dealings in these Data Files or Software without prior written authorization of the copyright holder.



**Important Notice:
U.S. LIMITED WARRANTY for Customers in the United States**

For detailed information about this Yamaha product and warranty service, please either visit the following website address (printable file is available at our website) or contact Customer Service at the address or telephone number identified below.

Website Address:
yamaha.io/DGXWarranty

Customer Service:
Yamaha Corporation of America
6600 Orangethorpe Avenue, Buena Park, CA 90620-1273
Telephone: 800-854-1569

For U.S.A.

This transmitter must not be co-located or operated in conjunction with any other antenna or transmitter.

This equipment complies with FCC radiation exposure limits set forth for an uncontrolled environment and meets the FCC radio frequency (RF) Exposure Guidelines. This equipment has very low levels of RF energy that is deemed to comply without maximum permissive exposure evaluation (MPE).

For CANADA

This equipment complies with ISED radiation exposure limits set forth for an uncontrolled environment and meets RSS-102 of the ISED radio frequency (RF) Exposure rules as this equipment has very low levels of RF energy.

Cet équipement est conforme aux limites d'exposition aux rayonnements énoncées pour un environnement non contrôlé et respecte les règles d'exposition aux fréquences radioélectriques (RF) CNR-102 de l'ISDE puisque cet appareil a un niveau très bas d'énergie RF.

This device contains licence-exempt transmitter(s)/receiver(s) that comply with Innovation, Science and Economic Development Canada's licence-exempt RSS(s). Operation is subject to the following two conditions:

1. This device may not cause interference.
2. This device must accept any interference, including interference that may cause undesired operation of the device.

L'émetteur/récepteur exempt de licence contenu dans le présent appareil est conforme aux CNR d'Innovation, Sciences et Développement économique Canada applicables aux appareils radio exempts de licence. L'exploitation est autorisée aux deux conditions suivantes :

1. L'appareil ne doit pas produire de brouillage;
2. L'appareil doit accepter tout brouillage radioélectrique subi, même si le brouillage est susceptible d'en compromettre le fonctionnement.

For EU countries

BG Bulgarian

ОПРОСТЕНА ЕС ДЕКЛАРАЦИЯ ЗА СЪОТВЕТСТВИЕ

C настоящото Yamaha Music Europe GmbH декларира, че този тип радиосъоръжение [DGX-670] е в съответствие с Директива 2014/53/ЕС. Цялостният текст на ЕС декларацията за съответствие може да се намери на следния интернет адрес:
<https://europe.yamaha.com/en/support/compliance/doc.html>

ES Spanish

DECLARACIÓN UE DE CONFORMIDAD SIMPLIFICADA

Por la presente, Yamaha Music Europe GmbH declara que el tipo de equipo radioeléctrico [DGX-670] es conforme con la Directiva 2014/53/UE. El texto completo de la declaración UE de conformidad está disponible en la dirección Internet siguiente:
<https://europe.yamaha.com/en/support/compliance/doc.html>

CS Czech

ZJEDNODUŠENÉ EU PROHLÁŠENÍ O SHODĚ

Tímto Yamaha Music Europe GmbH prohlašuje, že typ rádiového zařízení [DGX-670] je v souladu se směrnicí 2014/53/EU. Úplné znění EU prohlášení o shodě je k dispozici na této internetové adrese:
<https://europe.yamaha.com/en/support/compliance/doc.html>

DA Danish

FORENKLET EU-OVERENSSTEMMELSESERKLÆRING

Hermed erklærer Yamaha Music Europe GmbH, at radioudstyrstypen [DGX-670] er i overensstemmelse med direktiv 2014/53/EU. EU-overensstemmelseserklæringens fulde tekst kan findes på følgende internetadresse:
<https://europe.yamaha.com/en/support/compliance/doc.html>

DE German

VEREINFACHTE EU-KONFORMITÄTSERKLÄRUNG

Hiernit erklärt Yamaha Music Europe GmbH, dass der Funkanlagentyp [DGX-670] der Richtlinie 2014/53/EU entspricht. Der vollständige Text der EU-Konformitätserklärung ist unter der folgenden Internetadresse verfügbar:
<https://europe.yamaha.com/en/support/compliance/doc.html>

ET Estonian

LIHTSUSTATUD ELI VASTAVUSDEKLARATSIOON

Käesolevaga deklareerib Yamaha Music Europe GmbH, et käesolev raadioseadme tüüp [DGX-670] vastab direktiivi 2014/53/EL nõuetele. ELi vastavusdeklaratsiooni täielik tekst on kättesaadav järgmisel internetiaadressil:
<https://europe.yamaha.com/en/support/compliance/doc.html>

EL Greek

ΑΠΛΟΥΣΤΕΥΜΕΝΗ ΔΗΛΩΣΗ ΣΥΜΜΟΡΦΩΣΗΣ ΕΕ

Με την παρούσα ο/η Yamaha Music Europe GmbH, δηλώνει ότι ο ραδιοεξοπλισμός [DGX-670] πληροί την οδηγία 2014/53/ΕΕ. Το πλήρες κείμενο της δήλωσης συμμόρφωσης ΕΕ διατίθεται στην ακόλουθη ιστοσελίδα στο διαδίκτυο:
<https://europe.yamaha.com/en/support/compliance/doc.html>

EN English

SIMPLIFIED EU DECLARATION OF CONFORMITY

Hereby, Yamaha Music Europe GmbH declares that the radio equipment type [DGX-670] is in compliance with Directive 2014/53/EU. The full text of the EU declaration of conformity is available at the following internet address:
<https://europe.yamaha.com/en/support/compliance/doc.html>

FR French

DECLARATION UE DE CONFORMITE SIMPLIFIEE

Le soussigné, Yamaha Music Europe GmbH, déclare que l'équipement radioélectrique du type [DGX-670] est conforme à la directive 2014/53/UE. Le texte complet de la déclaration UE de conformité est disponible à l'adresse internet suivante:
<https://europe.yamaha.com/en/support/compliance/doc.html>

HR Croatian

POJEDNOSTAVLJENA EU IZJAVA O SUKLADNOSTI

Yamaha Music Europe GmbH ovime izjavljuje da je radijska oprema tipa [DGX-670] u skladu s Direktivom 2014/53/EU. Cjeloviti tekst EU izjave o sukladnosti dostupan je na sljedećoj internetskoj adresi:
<https://europe.yamaha.com/en/support/compliance/doc.html>

IT Italian

DICHIARAZIONE DI CONFORMITÀ UE SEMPLIFICATA

Il fabbricante, Yamaha Music Europe GmbH, dichiara che il tipo di apparecchiatura radio [DGX-670] è conforme alla direttiva 2014/53/UE. Il testo completo della dichiarazione di conformità UE è disponibile al seguente indirizzo Internet:
<https://europe.yamaha.com/en/support/compliance/doc.html>

LV Latvian

VIENKĀRŠOTA ES ATBILSTĪBAS DEKLARĀCIJA

Ar šo Yamaha Music Europe GmbH deklarē, ka radioiekārta [DGX-670] atbilst Direktīvai 2014/53/ES. Pilns ES atbilstības deklarācijas teksts ir pieejams šādā internetā vietnē:
<https://europe.yamaha.com/en/support/compliance/doc.html>

LT Lithuanian

SUPAPRASTINTA ES ATITIKTIES DEKLARACIJA

Aš, Yamaha Music Europe GmbH, patvirtinu, kad radijo įrenginių tipas [DGX-670] atitinka Direktivą 2014/53/ES. Visas ES atitikties deklaracijos tekstas prieinamas šiuo interneto adresu:
<https://europe.yamaha.com/en/support/compliance/doc.html>

HU Hungarian

EGYSZERŰSÍTETT EU-MEGFELELŐSÉGI NYILATKOZAT

Yamaha Music Europe GmbH igazolja, hogy a [DGX-670] típusú rádióberendezés megfelel a 2014/53/EU irányelvnek. Az EU-megfelelőségi nyilatkozat teljes szövege elérhető a következő internetes címen:
<https://europe.yamaha.com/en/support/compliance/doc.html>

NL Dutch

VEREENVOUDIGDE EU-CONFORMITEITSVERKLARING

Hierbij verklaar ik, Yamaha Music Europe GmbH, dat het type radioapparatuur [DGX-670] conform is met Richtlijn 2014/53/EU. De volledige tekst van de EU-conformiteitsverklaring kan worden geraadpleegd op het volgende internetadres:
<https://europe.yamaha.com/en/support/compliance/doc.html>

PL Polish

UPROSZCZONA DEKLARACJA ZGODNOŚCI UE

Yamaha Music Europe GmbH niniejszym oświadcza, że typ urządzenia radiowego [DGX-670] jest zgodny z dyrektywą 2014/53/UE. Pełny tekst deklaracji zgodności UE jest dostępny pod następującym adresem internetowym:
<https://europe.yamaha.com/en/support/compliance/doc.html>

PT Portuguese

DECLARAÇÃO UE DE CONFORMIDADE SIMPLIFICADA

O(a) abaixo assinado(a) Yamaha Music Europe GmbH declara que o presente tipo de equipamento de rádio [DGX-670] está em conformidade com a Diretiva 2014/53/UE. O texto integral da declaração de conformidade está disponível no seguinte endereço de Internet:
<https://europe.yamaha.com/en/support/compliance/doc.html>

RO Romanian

DECLARAȚIA UE DE CONFORMITATE SIMPLIFICATĂ

Prin prezenta, Yamaha Music Europe GmbH declară că tipul de echipamente radio [DGX-670] este în conformitate cu Directiva 2014/53/UE. Textul integral al declarației UE de conformitate este disponibil la următoarea adresă internet:
<https://europe.yamaha.com/en/support/compliance/doc.html>

SK Slovak

ZJEDNODUŠENÉ EÚ VYHLÁSENIE O ZHODE

Yamaha Music Europe GmbH týmto vyhlasuje, že rádiové zariadenie typu [DGX-670] je v súlade so smernicou 2014/53/EÚ. Úplné EÚ vyhlásenie o zhode je k dispozícii na tejto internetovej adrese:
<https://europe.yamaha.com/en/support/compliance/doc.html>

SL Slovenian

POENOSTAVLJENA IZJAVA EU O SKLADNOSTI

Yamaha Music Europe GmbH potrjuje, da je tip radijske opreme [DGX-670] skladen z Direktivo 2014/53/EU. Celotno besedilo izjave EU o skladnosti je na voljo na naslednjem spletnem naslovu:
<https://europe.yamaha.com/en/support/compliance/doc.html>

FI Finnish

YKSINKERTAISTETTU EU-VAATIMUSTENMUKAISUUSVAKUUTUS

Yamaha Music Europe GmbH vakuuttaa, että radiolaitetyyppi [DGX-670] on direktiivin 2014/53/EU mukainen. EU-vaatimustenmukaisuusvakuutuksen täysimittainen teksti on saatavilla seuraavassa internetosoitteessa:
<https://europe.yamaha.com/en/support/compliance/doc.html>

SV Swedish

FÖRENKLAD EU-FÖRSÄKRAN OM ÖVERENSSTÄMMELSE

Härmed försäkras Yamaha Music Europe GmbH att denna typ av radioustrustning [DGX-670] överensstämmer med direktiv 2014/53/EU. Den fullständiga texten till EU-försäkran om överensstämmelse finns på följande webbadress:
<https://europe.yamaha.com/en/support/compliance/doc.html>

TR Turkey

BASİTLEŞTİRİLMİŞ AVRUPA BİRLİĞİ UYGUNLUK BİLDİRİMİ

İşbu belge ile, Yamaha Music Europe GmbH, radyo cihaz tipinin [DGX-670], Direktif 2014/53/AB'ye uygunluğunu beyan eder. AB uyumu beyanının tam metni aşağıdaki internet adresinden edinilebilir:
<https://europe.yamaha.com/en/support/compliance/doc.html>

Important Notice: Guarantee Information for customers in European Economic Area (EEA) and Switzerland

Important Notice: Guarantee Information for customers in EEA* and Switzerland For detailed guarantee information about this Yamaha product, and Pan-EEA* and Switzerland warranty service, please either visit the website address below (Printable file is available at our website) or contact the Yamaha representative office for your country. * EEA: European Economic Area	English
Wichtiger Hinweis: Garantie-Information für Kunden in der EWR* und der Schweiz Für nähere Garantie-Information über dieses Produkt von Yamaha, sowie über den Pan-EWR*- und Schweizer Garantieservice, besuchen Sie bitte entweder die folgend angegebene Internetadresse (eine druckfähige Version befindet sich auch auf unserer Webseite), oder wenden Sie sich an den für Ihr Land zuständigen Yamaha-Vertrieb. * EWR: Europäischer Wirtschaftsraum	Deutsch
Remarque importante: informations de garantie pour les clients de l'EEE et la Suisse Pour des informations plus détaillées sur la garantie de ce produit Yamaha et sur le service de garantie applicable dans l'ensemble de l'EEE ainsi qu'en Suisse, consultez notre site Web à l'adresse ci-dessous (le fichier imprimable est disponible sur notre site Web) ou contactez directement Yamaha dans votre pays de résidence. * EEE : Espace Economique Européen	Français
Belangrijke mededeling: Garantie-informatie voor klanten in de EER* en Zwitserland Voor gedetailleerde garantie-informatie over dit Yamaha-product en de garantieservice in heel de EER* en Zwitserland, gaat u naar de onderstaande website (u vindt een afdrukbaar bestand op onze website) of neemt u contact op met de vertegenwoordiging van Yamaha in uw land. * EER: Europese Economische Ruimte	Nederlands
Aviso importante: información sobre la garantía para los clientes del EEE* y Suiza Para una información detallada sobre este producto Yamaha y sobre el soporte de garantía en la zona EEE* y Suiza, visite la dirección web que se incluye más abajo (la versión del archivo para imprimir esta disponible en nuestro sitio web) o póngase en contacto con el representante de Yamaha en su país. * EEE: Espacio Económico Europeo	Español
Avviso importante: informazioni sulla garanzia per i clienti residenti nell'EEA* e in Svizzera Per informazioni dettagliate sulla garanzia relativa a questo prodotto Yamaha e l'assistenza in garanzia nei paesi EEA* e in Svizzera, potete consultare il sito Web all'indirizzo riportato di seguito (è disponibile il file in formato stampabile) oppure contattare l'ufficio di rappresentanza locale della Yamaha. * EEA: Area Economica Europea	Italiano
Aviso importante: informações sobre as garantias para clientes da AEE* e da Suíça Para obter uma informação pormenorizada sobre este produto da Yamaha e o serviço de garantia na AEE* e na Suíça, visite o site a seguir (o arquivo para impressão está disponível no nosso site) ou entre em contato com o escritório de representação da Yamaha no seu país. * AEE: Área Económica Européia	Português
Σημαντική σημείωση: Πληροφορίες εγγύησης για τους πελάτες στον ΕΟΧ* και Ελλάδα Για λεπτομερείς πληροφορίες εγγύησης σχετικά με το παρόν προϊόν της Yamaha και την κάλυψη εγγύησης σε όλες τις χώρες του ΕΟΧ και την Ελλάδα, επισκεφτείτε την παρακάτω ιστοσελίδα (Εκτυπώσιμη μορφή είναι διαθέσιμη στην ιστοσελίδα μας) ή απευθυνθείτε στην αντιπροσωπεία της Yamaha στη χώρα σας. * ΕΟΧ: Ευρωπαϊκός Οικονομικός Χώρος	Ελληνικά
Viktigt: Garantiinformation för kunder i EES-området* och Schweiz För detaljerad information om denna Yamahaprodukt samt garantiservice i hela EES-området* och Schweiz kan du antingen besöka nedanstående webbadress (en utskriftsvänlig fil finns på webbplatsen) eller kontakta Yamahas officiella representant i ditt land. * EES: Europeiska Ekonomiska Samarbetsområdet	Svenska
Viktig merknad: Garantiinformasjon for kunder i EØS* og Sveits Detaljert garantiinformasjon om dette Yamaha-produktet og garantiservice for hele EØS-området* og Sveits kan fås enten ved å besøke nettstedene nedenfor (utskriftsversjon finnes på våre nettsider) eller kontakte Yamahas kontoret i landet der du bor. * EØS: Det europeiske økonomiske samarbeidsområdet	Norsk
Vigtig oplysning: Garantioplysninger til kunder i EØO* og Schweiz De kan finde detaljerede garantioplysninger om dette Yamaha-produkt og den fælles garantiserviceordning for EØO* (og Schweiz) ved at besøge det websted, der er angivet nedenfor (der findes en fil, som kan udskrives, på vores websted), eller ved at kontakte Yamahas nationale repræsentationskontor i det land, hvor De bor. * EØO: Det Europæiske Økonomiske Område	Dansk
Tärkeä ilmoitus: Takuutiedot Euroopan talusalueen (ETA)* ja Sveitsin asiakkaille Tämän Yamaha-tuotteen sekä ETA-alueen ja Sveitsin takuuta koskevat yksityiskohtaiset tiedot saatte alla olevasta nettiosoitteesta. (Tulostettava tiedosto saatavissa sivustollamme.) Voitte myös ottaa yhteyttä paikalliseen Yamaha-edustajaan. *ETA: Euroopan talusalue	Suomi
Ważne: Warunki gwarancyjne obowiązujące w EOG* i Szwajcarii Aby dowiedzieć się więcej na temat warunków gwarancyjnych tego produktu firmy Yamaha i serwisu gwarancyjnego w całym EOG* i Szwajcarii, należy odwiedzić wskazaną poniżej stronę internetową (Plik gotowy do wydruku znajduje się na naszej stronie internetowej) lub skontaktować się z przedstawicielstwem firmy Yamaha w swoim kraju. * EOG — Europejski Obszar Gospodarczy	Polski
Důležité oznámení: Záruční informace pro zákazníky v EHS* a ve Švýcarsku Podrobné záruční informace o tomto produktu Yamaha a záručním servisu v celém EHS* a ve Švýcarsku naleznete na níže uvedené webové adrese (soubor k tisku je dostupný na našich webových stránkách) nebo se můžete obrátit na zastoupení firmy Yamaha ve své zemi. * EHS: Evropský hospodářský prostor	Česky
Fontos figyelemzétetés: Garancia-információk az EGT* területén és Svájcban élő vásárlók számára A jelen Yamaha termékre vonatkozó részletes garancia-információk, valamint az EGT*-re és Svájcra kiterjedő garanciális szolgáltatás tekintetében keressék fel webhelyünket az alábbi címen (a webhelyen nyomtatható fájl is található), vagy pedig lépjen kapcsolatba az országában működő Yamaha képviselői irodával. * EGT: Európai Gazdasági Térség	Magyar
Oluline märkus: Garantiteave Euroopa Majanduspiirkonna (EMP)* ja Šveitsi klientidele Täpsema teabe saamiseks selle Yamaha toote garantii ning kogu Euroopa Majanduspiirkonna ja Šveitsi garantiiteeninduse kohta, külastage palun veebisaiti alljärgneval aadressil (meie saidil on saadaval printitav fail) või pöörduge Teie regiooni Yamaha esinduse poole. * EMP: Euroopa Majanduspiirkond	Eesti keel
Svarīgs paziņojums: garantijas informācija klientiem EEZ* un Šveicē Lai saņemtu detalizētu garantijas informāciju par šo Yamaha produktu, kā arī garantijas apkalpošanu EEZ* un Šveicē, lūdzam apmeklējiet zemāk norādīto tīmekļa vietnes adresi (tīmekļa vietnē ir pieejams drukājams fails) vai sazinieties ar jūsu valsti apkalpojošo Yamaha pārstāvniecību. * EEZ: Eiropas Ekonomikas zona	Latviešu
Dėmesio: informacija dėl garantijos pirkėjams EEE* ir Šveicarijoje Jei reikia išsamios informacijos apie šį „Yamaha“ produktą ir jo techninę priežiūrą visoje EEE* ir Šveicarijoje, apsilankykite mūsų svetainėje toliau nurodytu adresu (svetainėje yra spausdintinas failas) arba kreipkitės į „Yamaha“ atstovybę savo šaliai. *EEE – Europos ekonominė erdvė	Lietuvių kalba
Dôležité upozornenie: Informácie o záruke pre zákazníkov v EHP* a Švajčiarsku Podrobné informácie o záruke týkajúce sa tohto produktu od spoločnosti Yamaha a garančnom servise v EHP* a Švajčiarsku nájdete na webovej stránke uvedenej nižšie (na našej webovej stránke je k dispozícii súbor na tlač) alebo sa obráťte na zástupcu spoločnosti Yamaha vo svojej krajine. * EHP: Európsky hospodársky priestor	Slovenčina
Pomembno obvestilo: Informacije o garanciji za kupce v EGP* in Švici Za podrobnejše informacije o tem Yamahinem izdelku ter garancijskem servisu v celotnem EGP in Švici, obiščite spletno mesto, ki je navedeno spodaj (natisljiva datoteka je na voljo na našem spletnem mestu), ali se obrnite na Yamahinega predstavnika v svoji državi. * EGP: Evropski gospodarski prostor	Slovenščina
Важно съобщение: Информация за гаранцията за клиенти в ЕИП* и Швейцария За подробна информация за гаранцията за този продукт на Yamaha и гаранционното обслужване в паневропейската зона на ЕИП* и Швейцария или посетете посочения по-долу уеб сайт (на нашия уеб сайт има файл за печат), или се свържете с представителния офис на Yamaha във вашата страна. * ЕИП: Европейско икономическо пространство	Български език
Notificare importantă: Informații despre garanție pentru clienții din SEE* și Elveția Pentru informații detaliate privind acest produs Yamaha și serviciul de garanție Pan-SEE* și Elveția, vizitați site-ul la adresa de mai jos (fișierul imprimabil este disponibil pe site-ul nostru) sau contactați biroul reprezentanței Yamaha din țara dumneavoastră. * SEE: Spațiul Economic European	Limba română
Važna obavijest: Informacije o jamstvu za države EGP-a i Švicarske Za detaljne informacije o jamstvu za ovaj Yamahin proizvod te jamstvenom servisu za cijeli EGP i Švicarsku, molimo Vas da posjetite web-stranicu navedenu u nastavku ili kontaktirate ovlaštenog Yamahinog dobavljača u svojoj zemlji. * EGP: Evropski gospodarski prostor	Hrvatski

<https://europe.yamaha.com/warranty/>

For details of products, please contact your nearest Yamaha representative or the authorized distributor listed below.

Pour plus de détails sur les produits, veuillez-vous adresser à Yamaha ou au distributeur le plus proche de vous figurant dans la liste suivante.

Die Einzelheiten zu Produkten sind bei Ihrer unten aufgeführten Niederlassung und bei Yamaha Vertragshändlern in den jeweiligen Bestimmungsländern erhältlich.

Para detalles sobre productos, contacte su tienda Yamaha más cercana o el distribuidor autorizado que se lista debajo.

NORTH AMERICA

CANADA

Yamaha Canada Music Ltd.
135 Milner Avenue, Toronto, Ontario M1S 3R1,
Canada
Tel: +1-416-298-1311

U.S.A.

Yamaha Corporation of America
6600 Orangethorpe Avenue, Buena Park, CA 90620,
U.S.A.
Tel: +1-714-522-9011

CENTRAL & SOUTH AMERICA

MEXICO

Yamaha de México, S.A. de C.V.
Av. Insurgentes Sur 1647 Piso 9, Col. San José
Insurgentes, Delegación Benito Juárez, México,
D.F., C.P. 03900, México
Tel: +52-55-5804-0600

BRAZIL

Yamaha Musical do Brasil Ltda.
Rua Fidêncio Ramos, 302 – Cj 52 e 54 – Torre B –
Vila Olímpia – CEP 04551-010 – São Paulo/SP,
Brazil
Tel: +55-11-3704-1377

ARGENTINA

**Yamaha Music Latin America, S.A.,
Sucursal Argentina**
Olga Cossetini 1553, Piso 4 Norte,
Madero Este-C1107CEK,
Buenos Aires, Argentina
Tel: +54-11-4119-7000

PANAMA AND OTHER LATIN AMERICAN COUNTRIES/ CARIBBEAN COUNTRIES

Yamaha Music Latin America, S.A.
Edificio Torre Davivienda, Piso: 20
Avenida Balboa, Marbella, Corregimiento de Bella
Vista, Ciudad de Panamá, Rep. de Panamá
Tel: +507-269-5311

EUROPE

THE UNITED KINGDOM/IRELAND

Yamaha Music Europe GmbH (UK)
Sherbourne Drive, Tilbrook, Milton Keynes,
MK7 8BL, U.K.
Tel: +44-1908-366700

GERMANY

Yamaha Music Europe GmbH
Siemensstrasse 22-34, 25462 Rellingen, Germany
Tel: +49-4101-303-0

SWITZERLAND/LIECHTENSTEIN

**Yamaha Music Europe GmbH, Branch
Switzerland in Thalwil**
Seestrasse 18a, 8800 Thalwil, Switzerland
Tel: +41-44-3878080

AUSTRIA/CROATIA/CZECH REPUBLIC/ HUNGARY/ROMANIA/SLOVAKIA/ SLOVENIA

Yamaha Music Europe GmbH, Branch Austria
Schleiergasse 20, 1100 Wien, Austria
Tel: +43-1-60203900

POLAND

Yamaha Music Europe GmbH
Sp.z o.o. Oddział w Polsce
ul. Wielicka 52, 02-657 Warszawa, Poland
Tel: +48-22-880-08-88

BULGARIA

Dinacord Bulgaria LTD.
Bul. Iskarsko Schose 7 Targowski Zentar Ewropa
1528 Sofia, Bulgaria
Tel: +359-2-978-20-25

MALTA

Olimpus Music Ltd.
Valletta Road, Mosta MST9010, Malta
Tel: +356-2133-2093

NETHERLANDS/BELGIUM/ LUXEMBOURG

Yamaha Music Europe, Branch Benelux
Clarissenhof 5b, 4133 AB Vianen, The Netherlands
Tel: +31-347-358040

FRANCE

Yamaha Music Europe
7 rue Ambroise Croizat, Zone d'activités de Pariest,
77183 Croissy-Beaubourg, France
Tel: +33-1-6461-4000

ITALY

Yamaha Music Europe GmbH, Branch Italy
Via Tinelli N.67/69 20855 Gerno di Lesmo (MB),
Italy
Tel: +39-039-9065-1

SPAIN/PORTUGAL

**Yamaha Music Europe GmbH Ibérica, Sucursal
en España**
Ctra. de la Coruña km. 17,200, 28231
Las Rozas de Madrid, Spain
Tel: +34-91-639-88-88

GREECE

Philippos Nakas S.A. The Music House
19th km. Leof. Lavriou 190 02 Peania – Attiki,
Greece
Tel: +30-210-6686260

SWEDEN

**Yamaha Music Europe GmbH Germany filial
Scandinavia**
JA Wettergrensgata 1, 400 43 Göteborg, Sweden
Tel: +46-31-89-34-00

DENMARK

**Yamaha Music Denmark,
Fillial of Yamaha Music Europe GmbH, Tyskland**
Generatorvej 8C, ST. TH., 2860 Søborg, Denmark
Tel: +45-44-92-49-00

FINLAND

F-Musiikki Oy
Antaksentie 4
FI-01510 Vantaa, Finland
Tel: +358 (0)96185111

NORWAY

**Yamaha Music Europe GmbH Germany -
Norwegian Branch**
Grini Næringspark 1, 1332 Østerås, Norway
Tel: +47-6716-7800

ICELAND

Hljodfaerahusid Ehf.
Sidumula 20
IS-108 Reykjavik, Iceland
Tel: +354-525-5050

CYPRUS

Nakas Music Cyprus Ltd.
Nikis Ave 2k
1086 Nicosia
Tel: +357-22-511080
Major Music Center
21 Ali Riza Ave. Ortakoy
P.O.Box 475 Lefkoşa, Cyprus
Tel: (392) 227 9213

RUSSIA

Yamaha Music (Russia) LLC.
Room 37, entrance 7, bld. 7, Kievskaya street,
Moscow, 121059, Russia
Tel: +7-495-626-5005

OTHER EUROPEAN COUNTRIES

Yamaha Music Europe GmbH
Siemensstrasse 22-34, 25462 Rellingen, Germany
Tel: +49-4101-303-0

AFRICA

Yamaha Music Gulf FZE
JAFZA-16, Office 512, P.O.Box 17328,
Jebel Ali FZE, Dubai, UAE
Tel: +971-4-801-1500

MIDDLE EAST

TURKEY

Yamaha Music Europe GmbH
Merkezi Almanya Türkiye İstanbul Şubesi
Mor Sumbul Sokak Varyap Meridian Business
1.Blok No:1 113-114-115
Bati Atasehir Istanbul, Turkey
Tel: +90-216-275-7960

ISRAEL

RBX International Co., Ltd.
P.O Box 10245, Petach-Tikva, 49002
Tel: (972) 3-925-6900

OTHER COUNTRIES

Yamaha Music Gulf FZE
JAFZA-16, Office 512, P.O.Box 17328,
Jebel Ali FZE, Dubai, UAE
Tel: +971-4-801-1500

ASIA

THE PEOPLE'S REPUBLIC OF CHINA

Yamaha Music & Electronics (China) Co., Ltd.
2F, Yunhedasha, 1818 Xinzha-lu, Jingan-qu,
Shanghai, China
Tel: +86-400-051-7700

HONG KONG

Tom Lee Music Co., Ltd.
11/F, Silvercord Tower 1, 30 Canton Road,
Tsimshatsui, Kowloon, Hong Kong
Tel: +852-2737-7688

INDIA

Yamaha Music India Private Limited
P-401, JMD Megapolis, Sector-48, Sohna Road,
Gurgaon-122018, Haryana, India
Tel: +91-124-485-3300

INDONESIA

PT. Yamaha Musik Indonesia (Distributor)
Yamaha Music Center Bldg. Jalan Jend. Gatot
Subroto Kav. 4, Jakarta 12930, Indonesia
Tel: +62-21-520-2577

KOREA

Yamaha Music Korea Ltd.
11F, Prudential Tower, 298, Gangnam-daero,
Gangnam-gu, Seoul, 06253, Korea
Tel: +82-2-3467-3300

MALAYSIA

Yamaha Music (Malaysia) Sdn. Bhd.
No.8, Jalan Perbandaran, Kelana Jaya, 47301
Petaling Jaya, Selangor, Malaysia
Tel: +60-3-78030900

SINGAPORE

Yamaha Music (Asia) Private Limited
Block 202 Hougang Street 21, #02-00,
Singapore 530202, Singapore
Tel: +65-6740-9200

TAIWAN

Yamaha Music & Electronics Taiwan Co., Ltd.
2F, No.1, Yuanlong Rd., Banqiao Dist.,
New Taipei City 22063, Taiwan (R.O.C.)
Tel: +886-2-7741-8888

THAILAND

Siam Music Yamaha Co., Ltd.
3, 4, 15, 16th Fl., Siam Motors Building,
891/1 Rama 1 Road, Wangmai,
Pathumwan, Bangkok 10330, Thailand
Tel: +66-2215-2622

VIETNAM

Yamaha Music Vietnam Company Limited
15th Floor, Nam A Bank Tower, 201-203 Cach
Mang Thang Tam St., Ward 4, Dist.3,
Ho Chi Minh City, Vietnam
Tel: +84-28-3818-1122

OTHER ASIAN COUNTRIES

[https://asia-latinamerica-mea.yamaha.com/
index.html](https://asia-latinamerica-mea.yamaha.com/index.html)

OCEANIA

AUSTRALIA

Yamaha Music Australia Pty. Ltd.
Level 1, 80 Market Street, South Melbourne,
VIC 3205 Australia
Tel: +61-3-9693-5111

NEW ZEALAND

Music Works LTD
P.O. BOX 6246 Wellesley, Auckland 4680,
New Zealand
Tel: +64-9-634-0099

COUNTRIES AND TRUST

TERRITORIES IN PACIFIC OCEAN

[https://asia-latinamerica-mea.yamaha.com/
index.html](https://asia-latinamerica-mea.yamaha.com/index.html)

Yamaha Global Site

<https://www.yamaha.com/>

Yamaha Downloads

<https://download.yamaha.com/>

Manual Development Group
© 2020 Yamaha Corporation

Published 06/2020 MWMA* - **B0

VDD7370